

**G**

# VFD-G

## User Manual

Specific AC Motor Drives for Plastic Molding and Air Compressors Machinery



**Power Range:**

3-phase 460V series: 5.5~30kW

(7.5~40 HP)

3-phase 460V series: 37~75kW

(50~100HP)

3-phase 460V series : 90KW ~ 220KW

(125 ~ 300HP)



DELTA ELECTRONICS, INC.

[www.delta.com.tw/industrialautomation](http://www.delta.com.tw/industrialautomation)

## ASIA

### Delta Electronics, Inc.

#### Taoyuan1

31-1, Xingbang Road, Guishan Industrial Zone,  
Taoyuan County 33370, Taiwan, R.O.C.  
TEL: 886-3-362-6301 / FAX: 886-3-362-7267

### Delta Electronics (Jiang Su) Ltd.

#### Wujiang Plant3

1688 Jiangxing East Road,  
Wujiang Economy Development Zone,  
Wujiang City, Jiang Su Province,  
People's Republic of China (Post code: 215200)  
TEL: 86-512-6340-3008 / FAX: 86-512-6340-7290

### Delta Electronics (Japan), Inc.

#### Tokyo Office

Delta Shibadaimon Building, 2-1-14 Shibadaimon,  
Minato-Ku, Tokyo, 105-0012, Japan  
TEL: 81-3-5733-1111 / FAX: 81-3-5733-1211

### Delta Electronics (Korea), Inc.

234-9, Duck Soo BD 7F, Nonhyun-dong,  
Kangnam-ku, Seoul, Korea  
Post code : 135-010  
TEL: 82-2-515-5303/5 / FAX: 82-2-515-5302

### Delta Electronics (Singapore) Pte. Ltd.

8 Kaki Bukit Road 2, #04-18 Ruby Warehouse Complex,  
Singapore 417841  
TEL: 65-6747-5155 / FAX: 65-6744-9228

### Delta Energy Systems (India) Pvt. Ltd.

Plot No. 27 & 31, Sector-34, EHTP,  
Gurgaon-122001 Haryana, India  
TEL: 91-124-4169040 / FAX: 91-124-4036045

## AMERICA

### Delta Products Corporation (USA)

#### Raleigh Office

P.O. Box 12173, 5101 Davis Drive,  
Research Triangle Park, NC 27709, U.S.A.  
TEL: 1-919-767-3813 / FAX: 1-919-767-3969

## EUROPE

### Deltronics (Netherlands) B.V.

#### Eindhoven Office

De Witbogt 15, 5652 AG Eindhoven, The Netherlands  
TEL: 31-40-259-28-50 / FAX: 31-40-259-28-51

5011632003  
200807-25



EG03



**VFD-G**

***User Manual***

Specific AC Motor Drives for Plastic Molding and Air Compressors Machinery

## Preface

---

Thank you for choosing DELTA's VFD-G Series for plastic molding and air compressors machinery. The VFD-G Series is manufactured with high-quality components and materials and incorporates the latest microprocessor technology available.

This manual is to be used for the installation, parameter setting, troubleshooting, and daily maintenance of the AC motor drive. To guarantee safe operation of the equipment, read the following safety guidelines before connecting power to the AC motor drive. Keep this operating manual at hand and distribute to all users for reference.

To ensure the safety of operators and equipment, only qualified personnel familiar with AC motor drive are to do installation, start-up and maintenance. Always read this manual thoroughly before using VFD-G series AC Motor Drive, especially the WARNING, DANGER and CAUTION notes. Failure to comply may result in personal injury and equipment damage. If you have any questions, please contact your dealer.

### **PLEASE READ PRIOR TO INSTALLATION FOR SAFETY.**



- 
1. AC input power must be disconnected before any wiring to the AC motor drive is made.
  2. A charge may still remain in the DC-link capacitors with hazardous voltages, even if the power has been turned off. To prevent personal injury, please ensure that power has been turned off before opening the AC motor drive and wait ten minutes for the capacitors to discharge to safe voltage levels.
  3. Never reassemble internal components or wiring.
  4. The AC motor drive may be destroyed beyond repair if incorrect cables are connected to the input/output terminals. Never connect the AC motor drive output terminals U/T1, V/T2, and W/T3 directly to the AC mains circuit power supply.
  5. Ground the VFD-G using the ground terminal. The grounding method must comply with the laws of the country where the AC motor drive is to be installed. Refer to the Basic Wiring Diagram.
  6. VFD-G series is used only to control variable speed of 3-phase induction motors, NOT for 1-phase motors or other purpose.
  7. VFD-G series shall NOT be used for life support equipment or any life safety situation.

**WARNING!**

---

1. DO NOT use Hi-pot test for internal components. The semi-conductor used in the AC motor drive is easily damaged by high-pressure.
2. There are highly sensitive MOS components on the printed circuit boards. These components are especially sensitive to static electricity. To prevent damage to these components, do not touch these components or the circuit boards with metal objects or your bare hands.
3. Only qualified persons are allowed to install, wire and maintain AC motor drives.

**CAUTION!**

---

1. Some parameter settings will cause the motor to run immediately after applying power.
2. DO NOT install the AC motor drive in a place subjected to high temperature, direct sunlight, high humidity, excessive vibration, corrosive gases or liquids, or airborne dust or metallic particles.
3. Only use AC motor drives within specification. Failure to comply may result in fire, explosion or electric shock.
4. To prevent personal injury, please keep children and unqualified people away from the equipment.
5. When the motor cable between the AC motor drive and motor is too long, the layer insulation of the motor may be damaged. Please use a frequency inverter duty motor or add an AC output reactor to prevent damage to the motor. Refer to appendix B Reactor for details.
6. The rated voltage for the AC motor drive must be  $\leq 480V$  for 460V models and the mains supply current capacity must be  $\leq 5000A$  RMS ( $\leq 10000A$  RMS for the  $\geq 40hp$  (30kW) models).

# Table of Contents

---

<b>Preface</b> .....	<b>i</b>
<b>Table of Contents</b> .....	<b>iii</b>
<b>Chapter 1 Introduction</b> .....	<b>1-3</b>
1.1 Receiving and Inspection .....	1-3
1.1.1 Nameplate Information .....	1-3
1.1.2 Model Explanation .....	1-3
1.1.3 Series Number Explanation .....	1-3
1.1.4 Drive Frames .....	1-3
1.2 Appearances .....	1-3
1.3 Remove Instructions .....	1-3
1.3.1 Remove Keypad .....	1-3
1.3.2 Remove Front Cover .....	1-3
1.4 Lifting .....	1-3
1.5 Preparation for Installation and Wiring .....	1-3
1.5.1 Ambient Conditions .....	1-3
1.5.2 Minimum Mounting Clearances .....	1-3
1.6 Dimensions .....	1-3
<b>Chapter 2 Installation and Wiring</b> .....	<b>2-3</b>
2.1 Wiring .....	2-3
2.2 External Wiring .....	2-3

2.3 Main Circuit Connection.....	2-3
2.4 Control Terminals .....	2-3
2.5 Specification for main circuit terminals and control terminals.....	2-3
2.6 Wiring Explanation for Analog Input Terminal.....	2-3
<b>Chapter 3 Keypad and Start Up .....</b>	<b>3-3</b>
3.1 Digital Keypad VFD-PU01 .....	3-3
3.1.1 Description of the Digital Keypad .....	3-3
3.1.2 How to Operate the Digital Keypad VFD-PU01 .....	3-3
3.1.3 VFD-PU01 Dimensions .....	3-3
3.1.4 Reference Table for the LED Display of the Digital Keypad .....	3-3
3.2 Operation Method .....	3-3
3.3 Trial Run .....	3-3
<b>Chapter 4 Parameters .....</b>	<b>4-3</b>
4.1 Summary of Parameter Settings.....	4-3
4.2 Parameter Settings for Applications.....	4-3
4.3 Description of Parameter Settings .....	4-3
<b>Chapter 5 Troubleshooting .....</b>	<b>5-3</b>
5.1 Over Current (OC) .....	5-3
5.2 Ground Fault.....	5-3
5.3 Over Voltage (OV) .....	5-3
5.4 Low Voltage (Lv).....	5-3
5.5 Over Heat (OH).....	5-3
5.6 Overload .....	5-3
5.7 Keypad Display is Abnormal .....	5-3
5.8 Phase Loss (PHL).....	5-3

5.9 Motor cannot Run.....	5-3
5.10 Motor Speed cannot be Changed.....	5-3
5.11 Motor Stalls during Acceleration.....	5-3
5.12 The Motor does not Run as Expected.....	5-3
5.13 Electromagnetic/Induction Noise.....	5-3
5.14 Environmental Condition.....	5-3
5.15 Affecting Other Machines.....	5-3
<b>Chapter 6 Fault Code Information and Maintenance.....</b>	<b>6-3</b>
6.1 Fault Code Information.....	6-3
6.1.1 Common Problems and Solutions.....	6-3
6.1.2 Reset.....	6-3
6.2 Maintenance and Inspections.....	6-3
<b>Appendix A Specifications.....</b>	<b>A-3</b>
<b>Appendix B Accessories.....</b>	<b>B-3</b>
B.1 All Brake Resistors & Brake Units Used in AC Motor Drives.....	B-3
B.2 Non-fuse Circuit Breaker Chart.....	B-3
B.3 Fuse Specification Chart.....	B-3
B.4 AC Reactor.....	B-3
B.4.1 AC Input Reactor Recommended Value.....	B-3
B.4.2 AC Output Reactor Recommended Value.....	B-3
B.4.3 Applications.....	B-3
B.5 Zero Phase Reactor (RF220X00A).....	B-3
B.6 PU06.....	B-3
B.6.1 Description of the Digital Keypad VFD-PU06.....	B-3



B.6.2 Explanation of Display Message .....B-3

B.6.3 PU06 Operation Flow Chart.....B-3

**Appendix C How to Select the Right AC Motor Drive ..... C-3**

C.1 Capacity Formulas ..... C-3

C.2 General Precaution ..... C-3

C.3 How to Choose a Suitable Motor..... C-3

## 1.1 Receiving and Inspection

This VFD-G AC motor drive has gone through rigorous quality control tests at the factory before shipment. After receiving the AC motor drive, please check for the following:

- Check to make sure that the package includes an AC motor drive, the User Manual/Quick Start and CD, dust covers and rubber bushings.
- Inspect the unit to assure it was not damaged during shipment.
- Make sure that the part number indicated on the nameplate corresponds with the part number of your order.

### 1.1.1 Nameplate Information

Example for 10HP/7.5kW 3-phase 460V AC drive

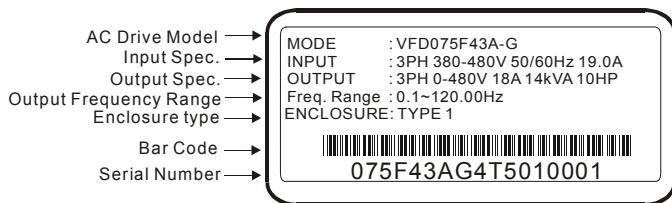

### 1.1.2 Model Explanation

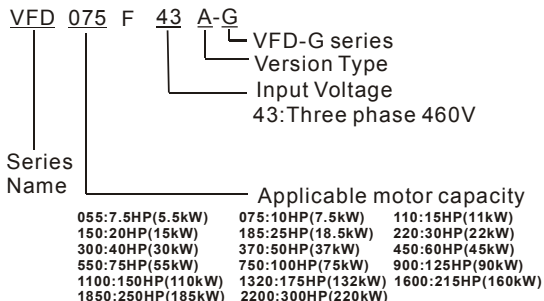

### 1.1.3 Series Number Explanation

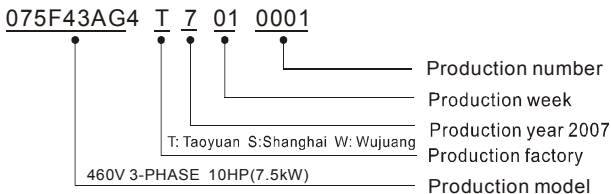

If the nameplate information does not correspond to your purchase order or if there are any problems, please contact your distributor.

### 1.1.4 Drive Frames

Frame	Power Range	Models
C	7.5-20HP (5.5-15kW)	VFD055F43B-G, VFD075F43B-G, VFD110F43A-G, VFD150F43A-G
D	25-40HP (18.5-30kW)	VFD185F43A-G, VFD220F43A-G, VFD300F43A-G
E	50-75HP (37-55kW)	VFD370F43A-G, VFD450F43A-G, VFD550F43A-G
E1	100-125HP (75-90kW)	VFD750F43A-G, VFD900F43C-G
G	150-215HP (110-160kW)	VFD1100F43C-G, VFD1320F43A-G, VFD1600F43A-G
H	250-300HP (185-220kW)	VFD1850F43A-G, VFD2200F43A-G

## 1.2 Appearances

(Refer to chapter 2.3 for exact dimensions)

7.5-20HP/5.5-15kW(Frame C)

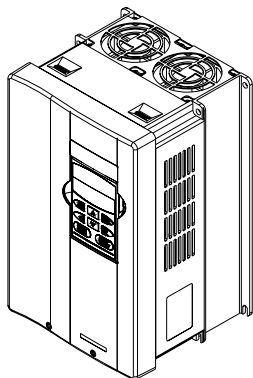

25-40HP/18.5-30kW(Frame D)

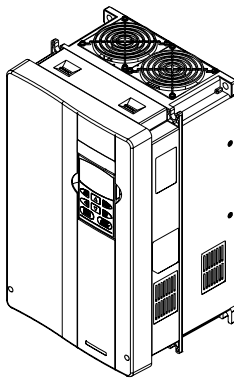

50-125HP/37-90kW(Frame E, E1)

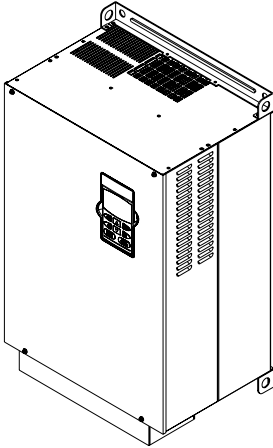

150-215HP/110-160kW(Frame G)

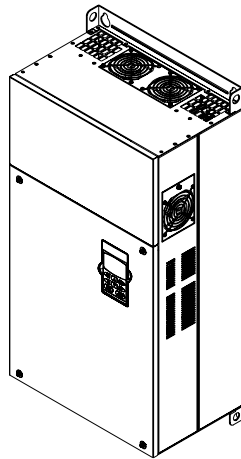

250-300HP/185-220kW(Frame H)

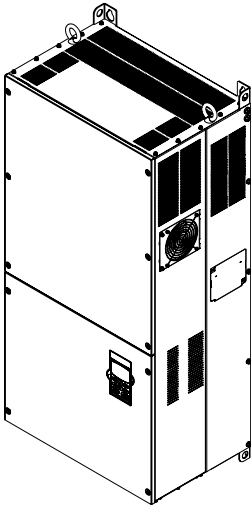

## 1.3 Remove Instructions

### 1.3.1 Remove Keypad

7.5-20HP/5.5-15kW(Frame C)

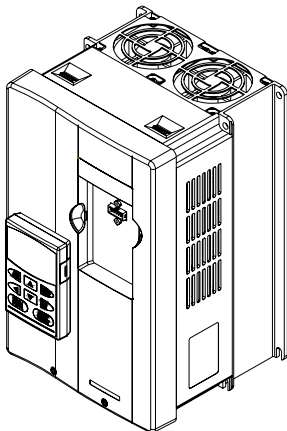

25-40HP/18.5-30kW(Frame D)

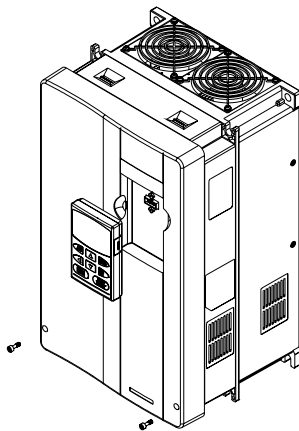

50-125HP/37-90kW(Frame E, E1)

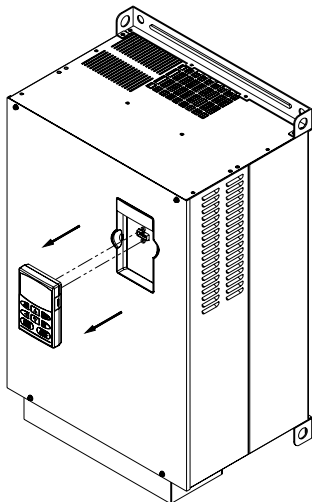

150-215HP/110-160kW(Frame G)

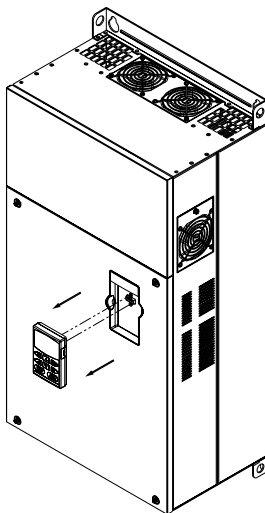

## 250-300HP/185-220kW(Frame H)

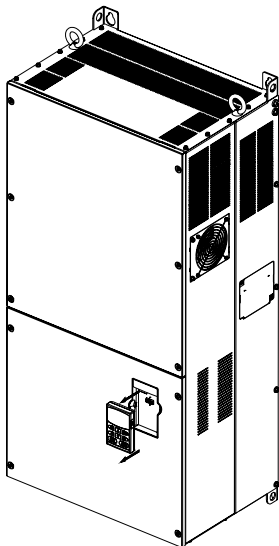

## 1.3.2 Remove Front Cover

## 7.5-20HP/5.5-15kW(Frame C)

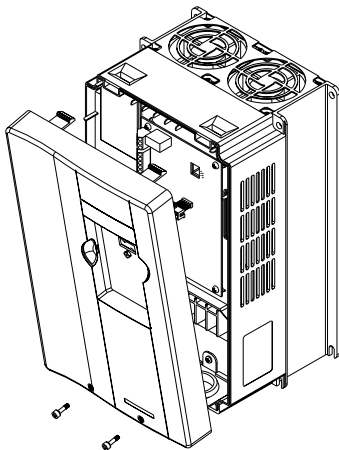

## 25-40HP/18.5-30kW(Frame D)

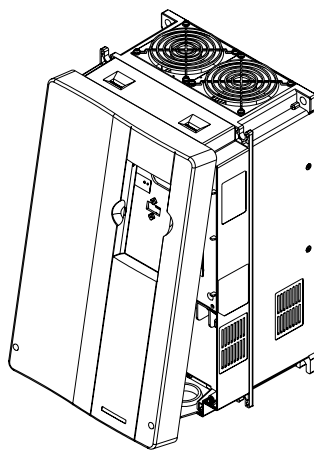

50-125HP/37-90kW(Frame E, E1)

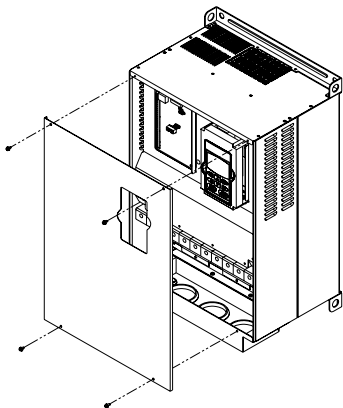

150-215HP/110-160kW(Frame G)

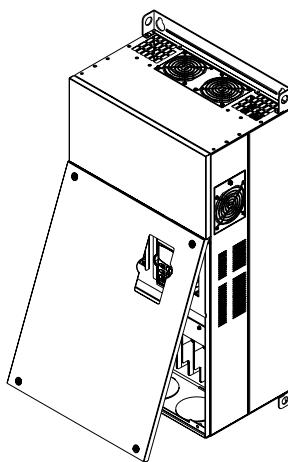

250-300HP/185-220kW(Frame H)

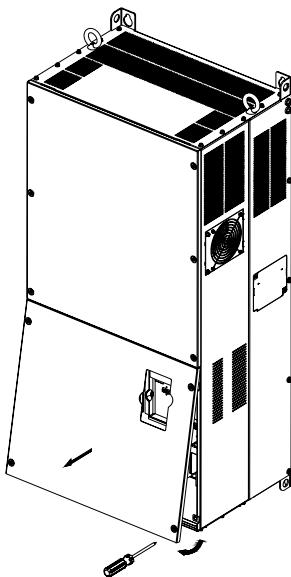

## 1.4 Lifting

Please carry only fully assembled AC motor drives as shown in the following.

**For 50-125HP (Frame E, E1)**

**Step 1**

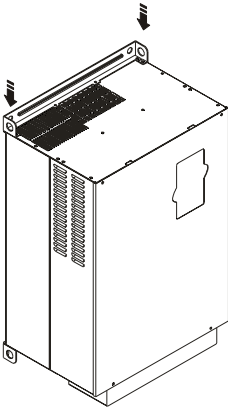

**Step 2**

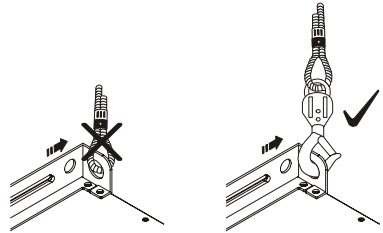

**Step 3**

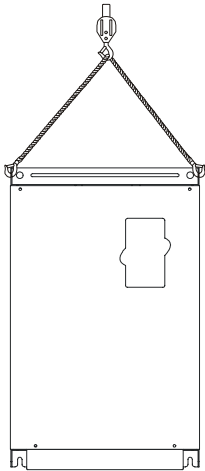

**Step 4**

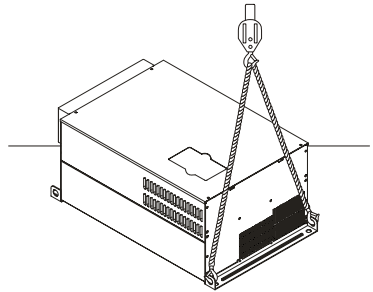



Step 1

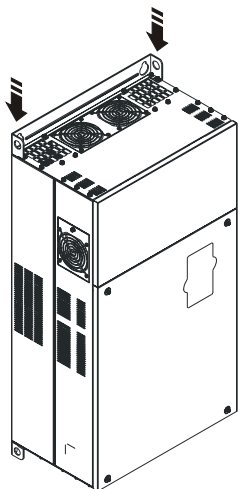

Step 2

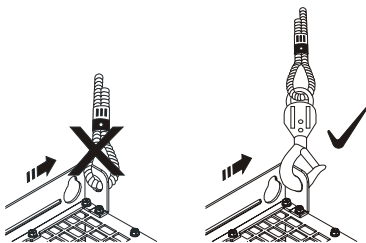

Step 3

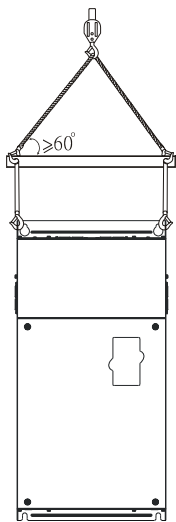

Step 4

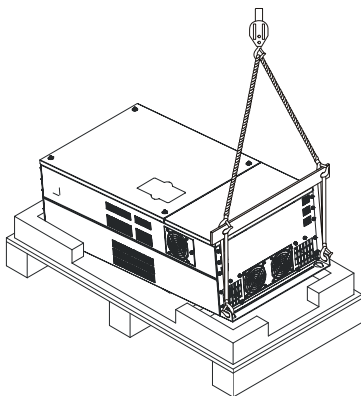

## For 250-300HP (Frame H)

Step 1

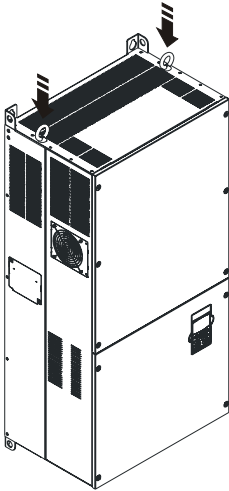

Step 2

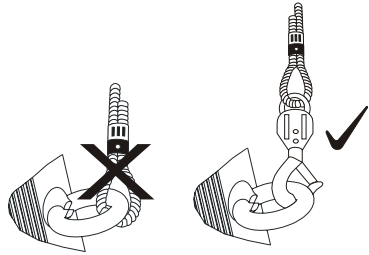

Step 3

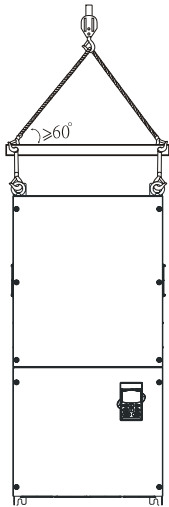

Step 4

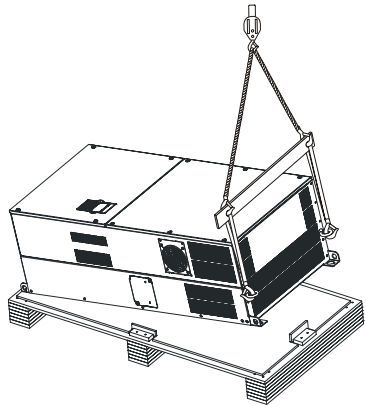

## 1.5 Preparation for Installation and Wiring

### 1.5.1 Ambient Conditions

Install the AC motor drive in an environment with the following conditions:

<b>Operation</b>	Air Temperature:	-10 ~ +40°C (14 ~ 104°F)
	Relative Humidity:	<90%, no condensation allowed
	Atmosphere pressure:	86 ~ 106 kPa
	Installation Site Altitude:	<1000m
	Vibration:	<20Hz: 9.80 m/s <sup>2</sup> (1G) max 20 ~ 50Hz: 5.88 m/s <sup>2</sup> (0.6G) max
<b>Storage Transportation</b>	Temperature:	-20°C ~ +60°C (-4°F ~ 140°F)
	Relative Humidity:	<90%, no condensation allowed
	Atmosphere pressure:	86 ~ 106 kPa
	Vibration:	<20Hz: 9.80 m/s <sup>2</sup> (1G) max 20 ~ 50Hz: 5.88 m/s <sup>2</sup> (0.6G) max
<b>Pollution Degree</b>	2: good for a factory type environment.	

### 1.5.2 Minimum Mounting Clearances

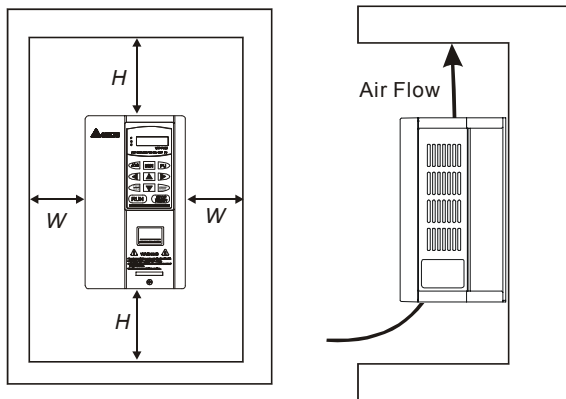

HP	W mm (inch)	H mm (inch)
1-5HP	50 (2)	150 (6)
7.5-20HP	75 (3)	175 (7)
25-75HP	75 (3)	200 (8)
100HP and above	75 (3)	250 (10)

**CAUTION!**

1. Operating, storing or transporting the AC motor drive outside these conditions may cause damage to the AC motor drive.
2. Failure to observe these precautions may void the warranty!
3. Mount the AC motor drive vertically on a flat vertical surface object by screws. Other directions are not allowed.
4. The AC motor drive will generate heat during operation. Allow sufficient space around the unit for heat dissipation.
5. The heat sink temperature may rise to 90°C when running. The material on which the AC motor drive is mounted must be noncombustible and be able to withstand this high temperature.
6. When AC motor drive is installed in a confined space (e.g. cabinet), the surrounding temperature must be within 10 ~ 40°C with good ventilation. DO NOT install the AC motor drive in a space with bad ventilation.
7. Prevent fiber particles, scraps of paper, saw dust, metal particles, etc. from adhering to the heatsink.
8. When installing multiple AC more drives in the same cabinet, they should be adjacent in a row with enough space in-between. When installing one AC motor drive below another one, use a metal separation between the AC motor drives to prevent mutual heating.

## 1.6 Dimensions

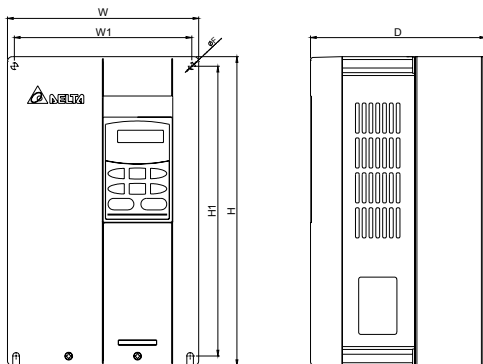

Unit: mm [inch]

Frame	W	W1	H	H1	D	F
C	200.0 [7.88]	185.6 [7.31]	323.0 [12.72]	303.0 [11.93]	183.2 [7.22]	7.0 [0.28]
D	250.0 [9.84]	226.0 [8.90]	403.8 [15.90]	384.0 [15.12]	205.4 [8.08]	10.0 [0.39]

### NOTE

Frame C: VFD055F43B-G, VFD075F43B-G, VFD110F43A-G, VFD150F43A-G

Frame D: VFD185F43A-G, VFD220F43A-G, VFD300F43A-G

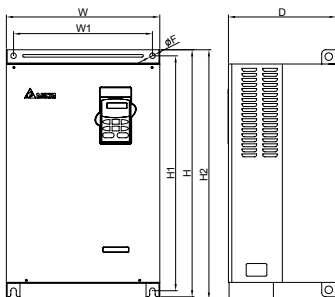

Unit: mm [inch]

Frame	W	W1	H	H1	H2	D	F
E	370.0[14.57]	335.0[13.19]	589.0[23.19]	560.0[22.05]	-	260.0[10.24]	13.0[0.51]
E1	370.0[14.57]	335.0[13.19]	589.0[23.19]	560.0[22.05]	595.0[23.43]	260.0[10.24]	13.0[0.51]

### NOTE

Frame E: VFD370F43A-G, VFD450F43A-G, VFD550F43A-G

Frame E1: VFD750F43A-G, VFD900F43C-G

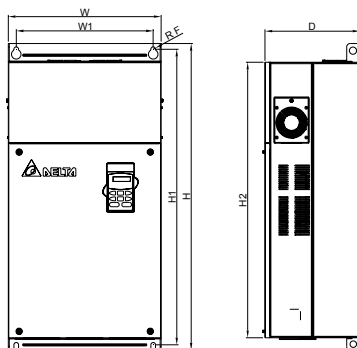

Unit: mm [inch]

Frame	W	W1	H	H1	H2	D	F
G	425.0[16.73]	381.0[15.00]	850.0[33.46]	819.5[32.26]	764.0[30.08]	264.0[10.39]	6.5[0.26]

**NOTE**

Frame G: VFD1100F43C-G, VFD1320F43A-G, VFD1600F43A-G

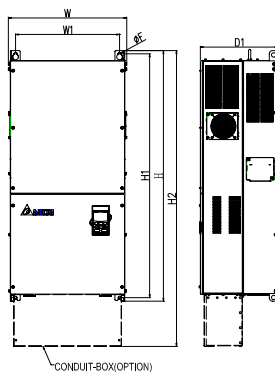

Unit: mm [inch]

Frame	W	W1	H	H1	H2	D1	F
H	547.0[21.54]	480.0[18.90]	1150.0[45.28]	1119.0[44.06]	1357.6[53.45]	360.0[14.17]	13.0[0.51]

**NOTE**

Frame H: VFD1850F43A-G, VFD2200F43A-G

This page intentionally left blank.

## Chapter 2 Installation and Wiring

---

After removing the front cover, check if the power and control terminals are clear. Be sure to observe the following precautions when wiring.

### ■ General Wiring Information

#### Applicable Codes

All VFD-G series are Underwriters Laboratories, Inc. (UL) and Canadian Underwriters Laboratories (cUL) listed, and therefore comply with the requirements of the National Electrical Code (NEC) and the Canadian Electrical Code (CEC).

Installation intended to meet the UL and cUL requirements must follow the instructions provided in "Wiring Notes" as a minimum standard. Follow all local codes that exceed UL and cUL requirements. Refer to the technical data label affixed to the AC motor drive and the motor nameplate for electrical data.

The "Line Fuse Specification" in Appendix B, lists the recommended fuse part number for each VFD-G Series part number. These fuses (or equivalent) must be used on all installations where compliance with U.L. standards is a required.



### **CAUTION!**

---

1. Make sure that power is only applied to the R/L1, S/L2, T/L3 terminals. Failure to comply may result in damage to the equipment. The voltage and current should lie within the range as indicated on the nameplate.
2. All the units must be grounded directly to a common ground terminal to prevent lightning strike or electric shock.
3. Please make sure to fasten the screw of the main circuit terminals to prevent sparks which is made by the loose screws due to vibration.
4. Check following items after finishing the wiring:
  - A. Are all connections correct?
  - B. No loose wires?
  - C. No short-circuits between terminals or to ground?





**DANGER!**

---

1. A charge may still remain in the DC bus capacitors with hazardous voltages even if the power has been turned off. To prevent personal injury, please ensure that the power is turned off and wait ten minutes for the capacitors to discharge to safe voltage levels before opening the AC motor drive.
2. Only qualified personnel familiar with AC motor drives is allowed to perform installation, wiring and commissioning.
3. Make sure that the power is off before doing any wiring to prevent electric shock.

## 2.1 Wiring

Users must connect wires according to the circuit diagrams on the following pages. Do not plug a modem or telephone line to the RS-485 communication port or permanent damage may result. Pins 1 & 2 are the power supply for the optional copy keypad only and should not be used for RS-485 communication.

For 460V series, 20hp and below

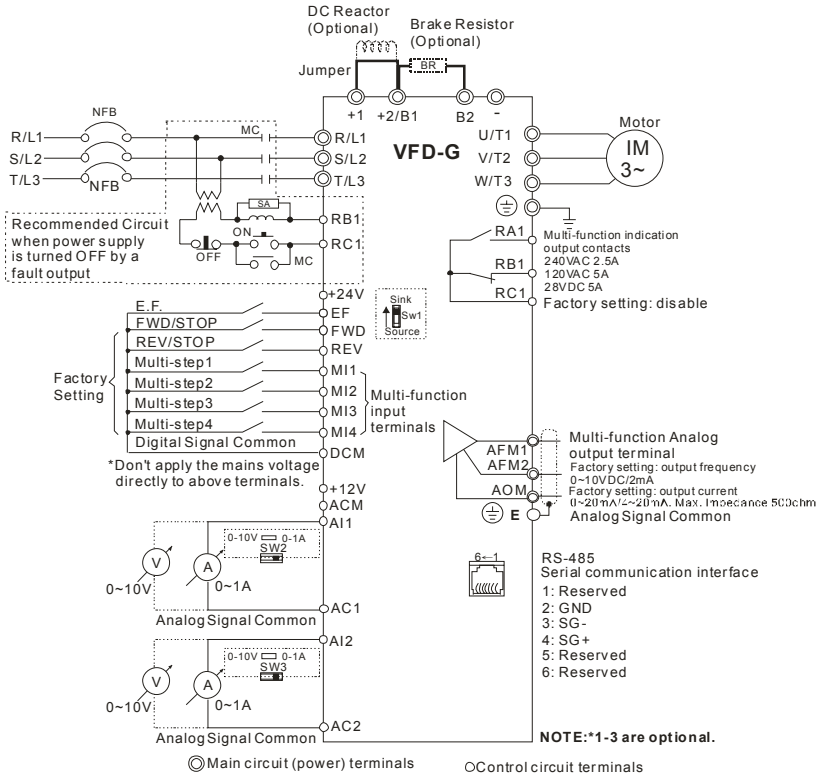

For 460V series, 25hp and above

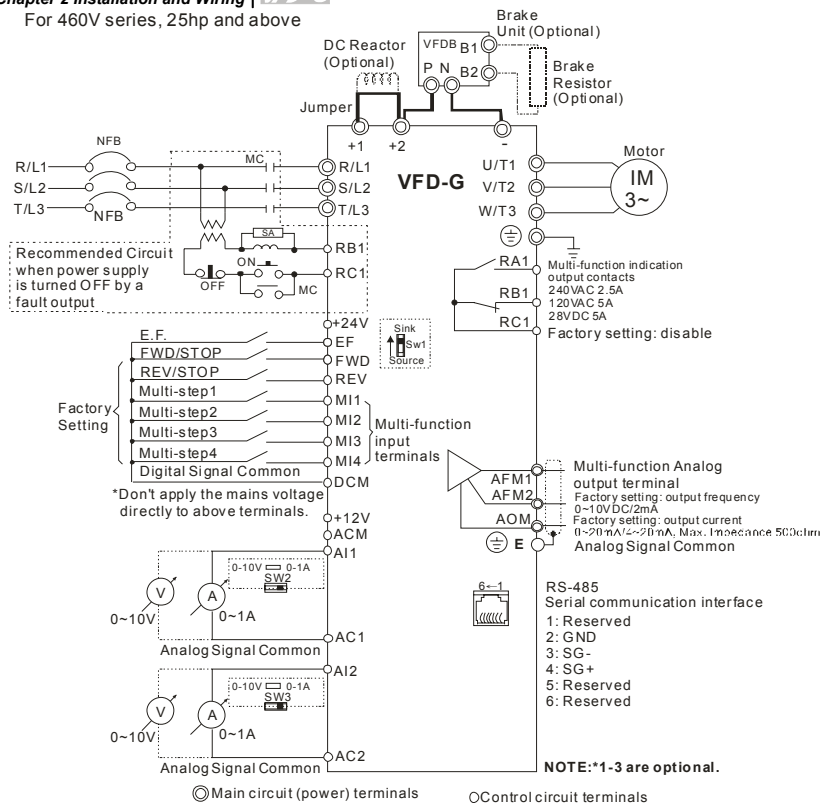

## Wiring for SINK mode and SOURCE mode

## SINK Mode

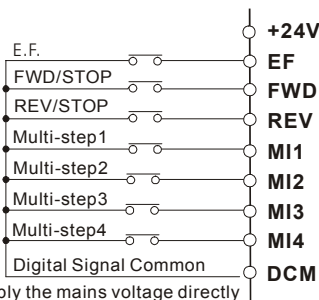

\*Don't apply the mains voltage directly to above terminals

## SOURCE Mode

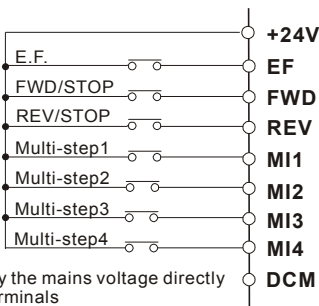

\*Don't apply the mains voltage directly to above terminals

**CAUTION!**

1. The wiring of main circuit and control circuit should be separated to prevent erroneous actions.
2. Please use shield wire for the control wiring and not to expose the peeled-off net in front of the terminal.
3. Please use the shield wire or tube for the power wiring and ground the two ends of the shield wire or tube.
4. Damaged insulation of wiring may cause personal injury or damage to circuits/equipment if it comes in contact with high voltage.
5. The AC motor drive, motor and wiring may cause interference. To prevent the equipment damage, please take care of the erroneous actions of the surrounding sensors and the equipment.
6. When the AC drive output terminals U/T1, V/T2, and W/T3 are connected to the motor terminals U/T1, V/T2, and W/T3, respectively. To permanently reverse the direction of motor rotation, switch over any of the two motor leads.

7. With long motor cables, high capacitive switching current peaks can cause over-current, high leakage current or lower current readout accuracy. To prevent this, the motor cable should be less than 20m for 3.7kW models and below. And the cable should be less than 50m for 5.5kW models and above. For longer motor cables use an AC output reactor.
8. The AC motor drive, electric welding machine and the greater horsepower motor should be grounded separately.
9. Use ground leads that comply with local regulations and keep them as short as possible.
10. No brake resistor is built in the VFD-G series, it can install brake resistor for those occasions that use higher load inertia or frequent start/stop. Refer to Appendix B for details.
11. Multiple VFD-G units can be installed in one location. All the units should be grounded directly to a common ground terminal, as shown in the figure below. **Ensure there are no ground loops.**

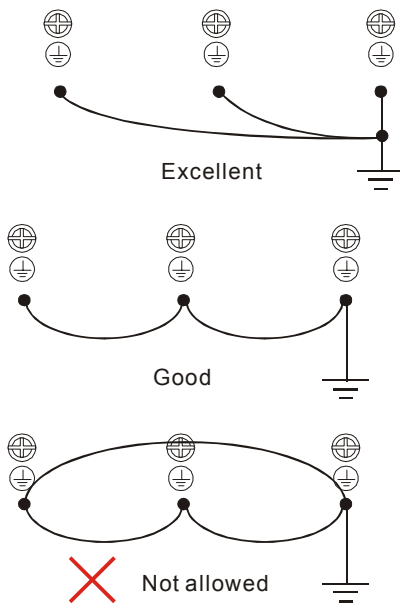

## 2.2 External Wiring

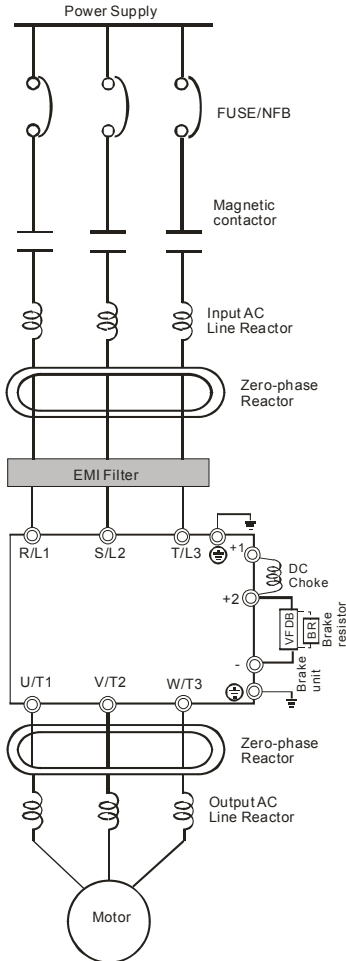

Items	Explanations
Power supply	Please follow the specific power supply requirements shown in Appendix A.
Fuse/NFB (Optional)	There may be an inrush current during power up. Please check the chart of Appendix B and select the correct fuse with rated current. Use of an NFB is optional.
Magnetic contactor (Optional)	Please do not use a Magnetic contactor as the I/O switch of the AC motor drive, as it will reduce the operating life cycle of the AC drive.
Input AC Line Reactor (Optional)	Used to improve the input power factor, to reduce harmonics and provide protection from AC line disturbances (surges, switching spikes, short interruptions, etc.). AC line reactor should be installed when the power supply capacity is $\geq 500\text{kVA}$ or phase lead reactor will be switched. And the mains wiring distance $\leq 10\text{m}$ . Please refer to Appendix B for more details.
Zero-phase Reactor (Ferrite Core Common Choke) (Optional)	Zero phase reactors are used to reduce radio noise especially when audio equipment is installed near the inverter. Effective for noise reduction on both the input and output sides. Attenuation quality is good for a wide range from AM band to 10MHz. Appendix B specifies the zero phase reactor. (RF220X00A)
EMI filter (Optional)	To reduce electromagnetic interference, please refer to Appendix B for more details.
Brake Resistor (Optional)	Used to reduce the deceleration time of the motor. Please refer to the chart in Appendix B for specific Brake Resistors.
Output AC Line Reactor (Optional)	Motor surge voltage amplitude depends on motor cable length. For applications with long motor cable ( $>20\text{m}$ ), it is necessary to install a reactor at the inverter output side.

## 2.3 Main Circuit Connection

For 460V series, 20hp and below

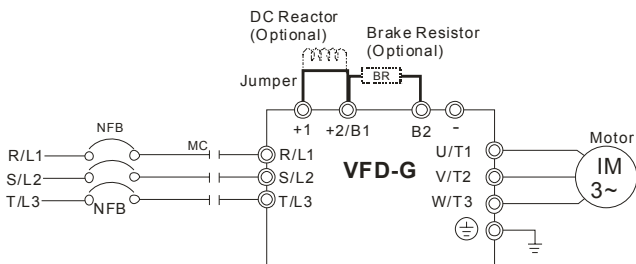

For 460V series, 25hp and above

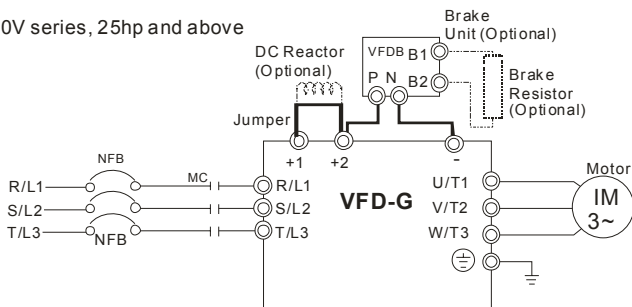

Terminal Symbol	Explanation of Terminal Function
R/L1, S/L2, T/L3	AC line input terminals
U/T1, V/T2, W/T3	AC drive output terminals motor connections
+1, +2	Connections for DC Link Reactor (optional)
+2/B1~B2	Connections for Braking Resistor (optional)
+2~ -, +2/B1~ -	Connections for External Braking Unit (VFDB series)
	Earth Ground

**CAUTION!****Mains power terminals (R/L1, S/L2, T/L3)**

- Connect these terminals (R/L1, S/L2, T/L3) via a non-fuse breaker or earth leakage breaker to 3-phase AC power (some models to 1-phase AC power) for circuit protection. It is unnecessary to consider phase-sequence.
- It is recommended to add a magnetic contactor (MC) in the power input wiring to cut off power quickly and reduce malfunction when activating the protection function of AC motor drives. Both ends of the MC should have an R-C surge absorber.
- Please make sure to fasten the screw of the main circuit terminals to prevent sparks which is made by the loose screws due to vibration.
- Please use voltage and current within the regulation shown in Appendix A.
- When using a general GFCI (Ground Fault Circuit Interrupter), select a current sensor with sensitivity of 200mA or above, and not less than 0.1-second detection time to avoid nuisance tripping. For the specific GFCI of the AC motor drive, please select a current sensor with sensitivity of 30mA or above.
- Do NOT run/stop AC motor drives by turning the power ON/OFF. Run/stop AC motor drives by RUN/STOP command via control terminals or keypad. If you still need to run/stop AC drives by turning power ON/OFF, it is recommended to do so only ONCE per hour.
- Do NOT connect 3-phase models to a 1-phase power source.

**Output terminals for main circuit (U, V, W)**

- When it needs to install the filter at the output side of terminals U/T1, V/T2, W/T3 on the AC motor drive. Please use inductance filter. Do not use phase-compensation capacitors or L-C (Inductance-Capacitance) or R-C (Resistance-Capacitance), unless approved by Delta.
- DO NOT connect phase-compensation capacitors or surge absorbers at the output terminals of AC motor drives.
- Use well-insulated motor, suitable for inverter operation.

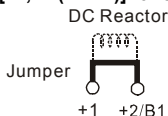
**Terminals [+1, +2(+2/B1)] for connecting DC reactor**

For 460V series, 20HP and below

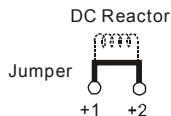

For 460V series, 25HP and above



- To improve the power factor and reduce harmonics, connect a DC reactor between terminals [+1, +2(+2/B1)]. Please remove the jumper before connecting the DC reactor.
- Models of 18.5kW~160kW have a built-in DC reactor; models of 185kW~220kW have a built-in AC reactor.

**Terminals [+2/B1, B2] for connecting brake resistor and terminals [+2(+2/B1), -] for connecting external brake unit**

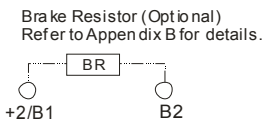

For 460V series, 20HP and below

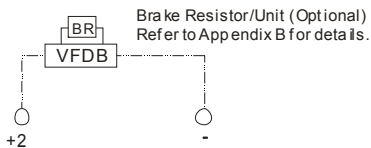

For 460V series, 25HP and above

- Connect a brake resistor or brake unit in applications with frequent deceleration ramps, short deceleration time, too low brake torque or requiring increased brake torque.
- If the AC motor drive has a built-in brake chopper (all models of 15kW and below), connect the external brake resistor to the terminals [+2/B1, B2].
- Models of 18.5kW and above don't have a built-in brake chopper. Please connect an external optional brake unit (VFDB-series) and brake resistor. Refer to VFDB series user manual for details.
- When not used, please leave the terminals [+2(+2/B1), -] open.
- Short-circuiting [B2] or [-] to [+2/B1] can damage the AC motor drive.
- Connect the terminals [+ (P), - (N)] of the brake unit to the AC motor drive terminals [+2(+2/B1), -]. The length of wiring should be less than 5m with twisted cable.

## 2.4 Control Terminals

Terminal Symbol	Terminal Function	Factory Settings
FWD	Forward-Stop command	FWD-DCM: ON: Run in FWD direction OFF: Ramp to stop
REV	Reverse-Stop command	REV-DCM: ON: Run in REV direction OFF: Ramp to stop
EF	External fault	EF-DCM: ON: External Fault. Display "EF" and coast/ramp to stop OFF: No fault
MI1	Multi-function Input 1	MI1~MI4-DCM: Refer to Pr.04-00~Pr.04-03 for programming multi-function inputs. ON: the activation current is 16mA. OFF: leakage current tolerance is 10 $\mu$ A.
MI2	Multi-function Input 2	
MI3	Multi-function Input 3	
MI4	Multi-function Input 4	
+24V	DC Voltage Source	+24V 20mA used for Source mode.
DCM	Digital Signal Common	Used as common for digital inputs and used for Sink mode.
AFM1	Analog output meter 1	0 to 10V, 2mA Impedance: 470 $\Omega$ Output current: 2mA max Resolution: 8 bits Range: 0 ~ 10VDC Function: Pr.03-05
AFM2	Analog output meter 2	Load Impedance: $\leq$ 500 $\Omega$ Output current: 20mA max Resolution: 8 bits Range: 0/4 ~ 20mA Function: Pr.03-06
AOM	Analog control signal common	Used as common for analog outputs.
RA1	Multi-function Relay1 output (N.O.) a	Resistive Load: 5A(N.O.)/3A(N.C.) 240VAC 5A(N.O.)/3A(N.C.) 24VDC
RB1	Multi-function Relay1 output (N.C.) b	Inductive Load: 1.5A(N.O.)/0.5A(N.C.) 240VAC
RC1	Multi-function Relay1 common	1.5A(N.O.)/0.5A(N.C.) 24VDC Refer to Pr.03-00 for programming.

Terminal Symbol	Terminal Function	Factory Settings
+12V/ACM	Potentiometer power source	+12Vdc 20mA (Variable Resistor: 3~5KΩ)
AI1	Analog voltage/current Input	0~10V/0~1A correspond to 0~Max. operation frequency Resolution: 10 bits Function: Pr.04-05 ~ Pr.04-25
AI2	Analog voltage/current Input	0~10V/0~1A correspond to 0~Max. operation frequency Resolution: 10 bits Function: Pr.04-05 ~ Pr.04-25
AC1/AC2	Analog control signal common	Used as common for analog inputs.

NOTE: Control signal wiring size: 18 AWG (0.75 mm<sup>2</sup>) with shielded wire.

### Analog inputs (AI1, AI2, AC1, AC2)

- Analog input signals are easily affected by external noise. Use shielded wiring and keep it as short as possible (<20m) with proper grounding. If the noise is inductive, connecting the shield to terminal AC1/AC2 can bring improvement.
- If the analog input signals are affected by noise from the AC motor drive, please connect a capacitor (0.1 μF and above) and ferrite core as indicated in the following diagrams:

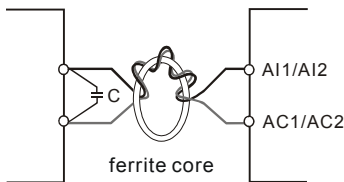

wind each wires 3 times or more around the core

### Digital inputs (MI1~MI4, DCM, FWD, REV, EF)

- When using contacts or switches to control the digital inputs, please use high quality components to avoid contact bounce.

### Relay outputs (RA1, RB1, RC1)

- Make sure to connect the digital outputs to the right polarity, see wiring diagrams.
- When connecting a relay to the digital outputs, connect a surge absorber or fly-back diode across the coil and check the polarity.

**General**

- Keep control wiring as far away as possible from the power wiring and in separate conduits to avoid interference. If necessary let them cross only at 90° angle.
- The AC motor drive control wiring should be properly installed and not touch any live power wiring or terminals.

 **NOTE**

- If a filter is required for reducing EMI (Electro Magnetic Interference), install it as close as possible to AC drive. EMI can also be reduced by lowering the Carrier Frequency.

 **DANGER!**

---

Damaged insulation of wiring may cause personal injury or damage to circuits/equipment if it comes in contact with high voltage.

## 2.5 Specification for main circuit terminals and control terminals

7.5 HP to 20 HP (VFD055F43B-G, VFD075F43B-G, VFD110F43A-G, VFD150F43A-G)

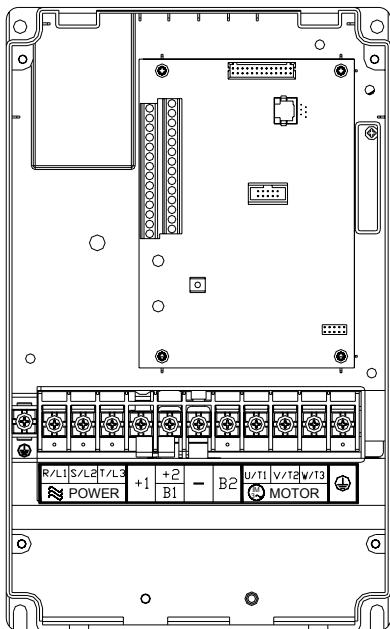

Control Terminal

Torque: 4Kgf-cm (3 in-lbf)

Wire: 12-24 AWG

Power Terminal

Torque: 30Kgf-cm (26 in-lbf)

Wire: 12-8 AWG

Wire Type: Stranded copper only, 75° C

NOTE: If wiring of the terminal utilizes the wire with a 6AWG-diameter, it is thus necessary to use the Recognized Ring Terminal to conduct a proper wiring.

## 25 HP to 40 HP (VFD185F43A-G, VFD220F43A-G, VFD300F43A-G)

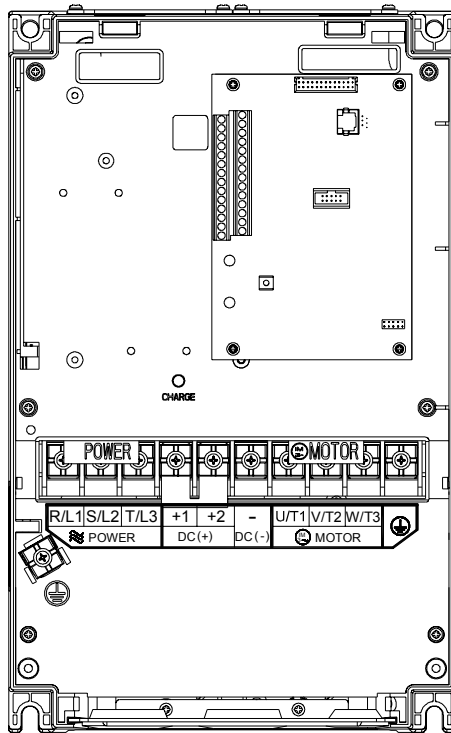

Control Terminal

Torque: 4Kgf-cm (3 in-lbf)

Wire: 12-24 AWG

Power Terminal

Torque: 30Kgf-cm (26 in-lbf)

Wire: 8-2 AWG

Wire Type: Stranded copper only, 75° C

NOTE: If wiring of the terminal utilizes the wire with a 1AWG-diameter, it is thus necessary to use the Recognized Ring Terminal to conduct a proper wiring.

50 HP to 60 HP (VFD370F43A-G, VFD450F43A-G)

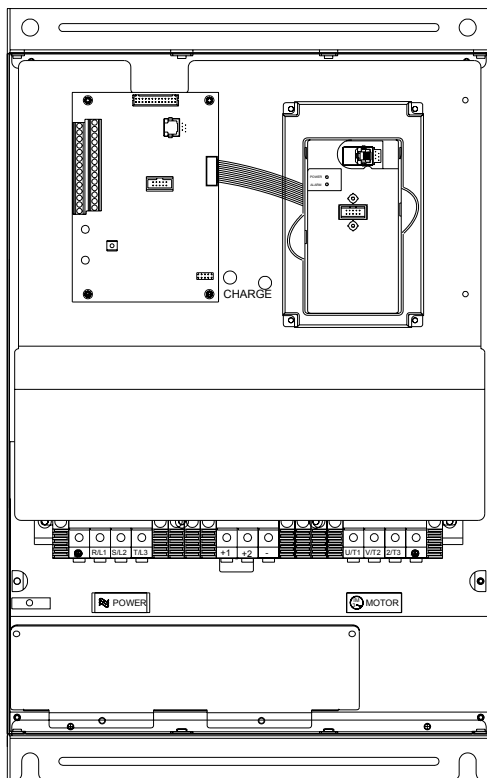

Control Terminal

Torque: 4Kgf-cm (3 in-lbf)

Wire: 12-24 AWG

Power Terminal

Torque: 57kgf-cm (49.5 in-lbf) min.

Wire: VFD370F43A-G: 3AWG

VFD450F43A-G: 2AWG

Wire Type: Stranded copper only, 75° C

## 75 HP to 125 HP (VFD550F43A-G, VFD750F43A-G, VFD900F43C-G)

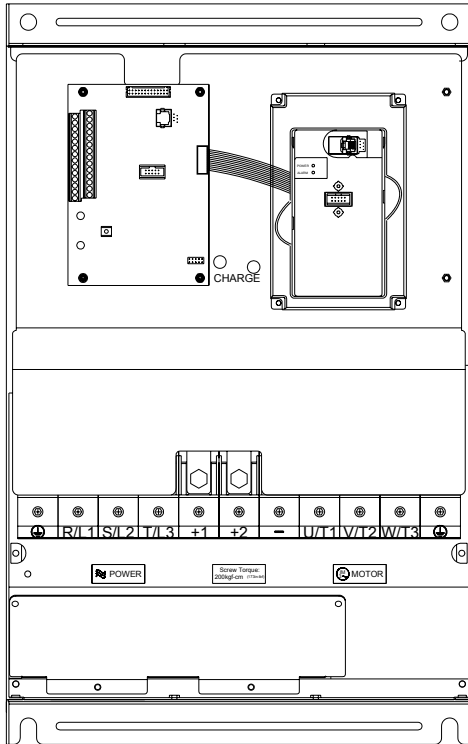

Control Terminal

Torque: 4Kgf-cm (3 in-lbf)

Wire: 12-24 AWG

Power Terminal

Torque: 200kgf-cm (173 in-lbf)

Wire: VFD550F43A-G: 1/0-4/0 AWG

VFD750F43A-G: 3/0-4/0 AWG

VFD900F43C-G: 4/0 AWG

Wire Type: Stranded copper only, 75°C



150 HP to 215 HP (VFD1100F43C-G, VFD1320F43A-G, VFD1600F43A-G)

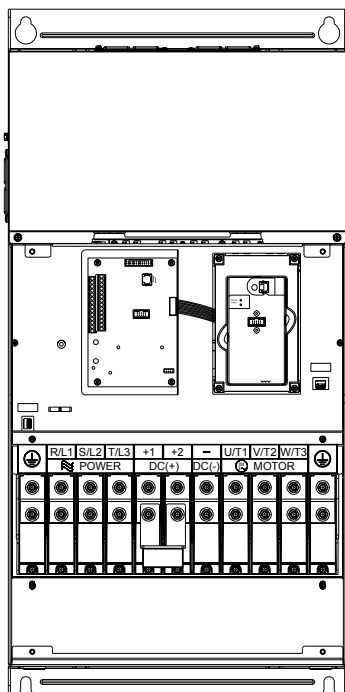

Control Terminal  
 Torque: 4Kgf-cm (3 in-lbf)  
 Wire: 12-24 AWG

Power Terminal  
 Torque: 300kgf-cm (260 in-lbf)  
 Wire: 1/0 AWG\*2-300 MCM\*2  
 Wire Type: Stranded copper only, 75°C

**NOTE:** It needs following additional terminal when wiring. The additional terminal dimension should comply with the following figure.

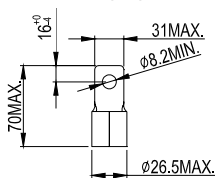

UNIT:mm

## 250 HP to 300 HP (VFD1850F43A-G, VFD2200F43A-G)

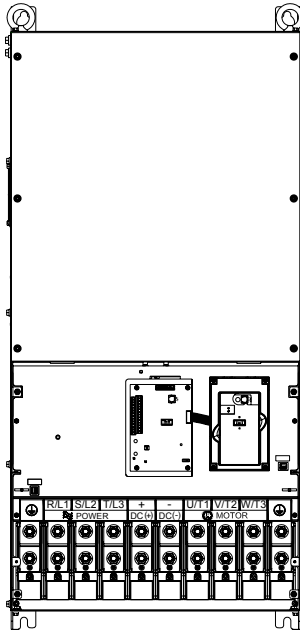

## Control Terminal

Torque: 4Kgf-cm (3 in-lbf)

Wire: 12-24 AWG

## Power Terminal

Torque: 408kgf-cm (354 in-lbf)

Wire: 500 MCM (max)

Wire Type: Stranded copper only, 75°C

**NOTE:** It needs following additional terminal when wiring, and add insulation sheath on position where following figure shows.

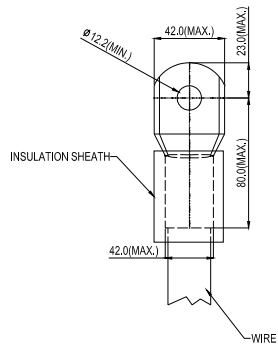



1. When using analog current input (0~1A), please plug into the left two pins (See the red mark), and make sure the jumper is connected well (See what the following yellow arrows point at).

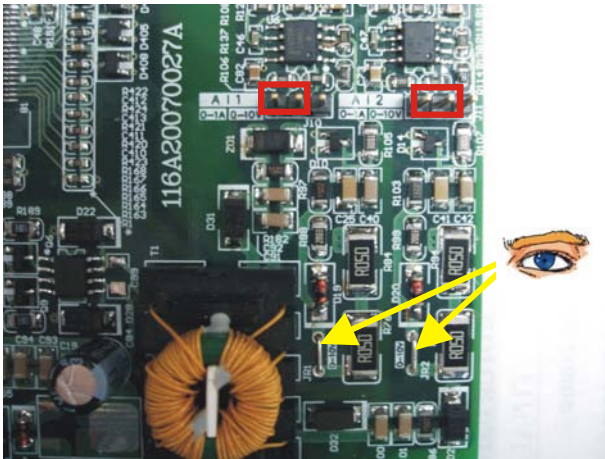

2. When using analog voltage input (0~10V), please transfer to the right two pins (See the red mark), and cut off the jumper (See what the following yellow arrows point at).

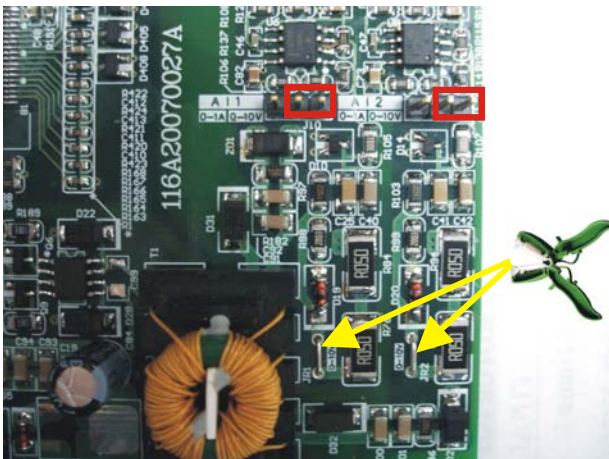

This page intentionally left blank.

## Chapter 3 Keypad and Start Up

### 3.1 Digital Keypad VFD-PU01

#### 3.1.1 Description of the Digital Keypad

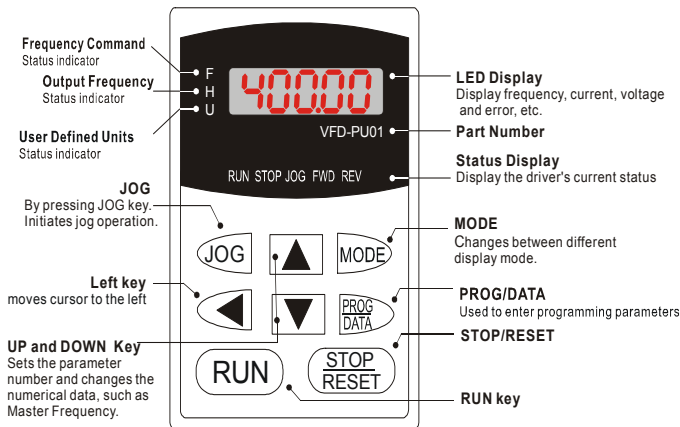

Display Message	Descriptions
	Display the AC drive Master Frequency.
	Display the actual operation frequency present at terminals U/T1, V/T2, and W/T3.
	Display voltage (V), Current (A), power factor and feedback signal (P)
	Display the output current present at terminals U/T1, V/T2, and W/T3.
	Display the AC drive forward run status.
	The AC drive reverse run status.
	Display the specified parameter setting.
	Display the actual value stored within the specified parameter.
	External Fault.

Display Message	Descriptions
	Display "End" for approximately 1 second if input has been accepted. After a parameter value has been set, the new value is automatically stored in memory. To modify an entry, use the ▲ or ▼ keys.
	Display "Err", if the input is invalid.

### 3.1.2 How to Operate the Digital Keypad VFD-PU01

#### Selecting mode

##### START



Note : In the selection mode, press to set the parameters.

#### Setting parameters

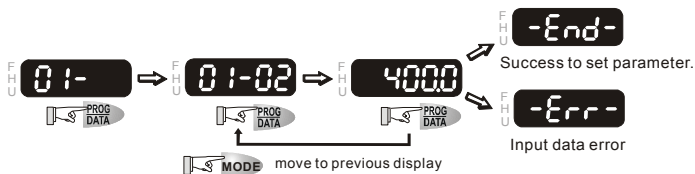

NOTE :In the parameter setting mode, you can press to return the selecting mode.

#### To shift data

##### START



#### To modify data

##### START



#### Setting direction



## 3.1.3 VFD-PU01 Dimensions

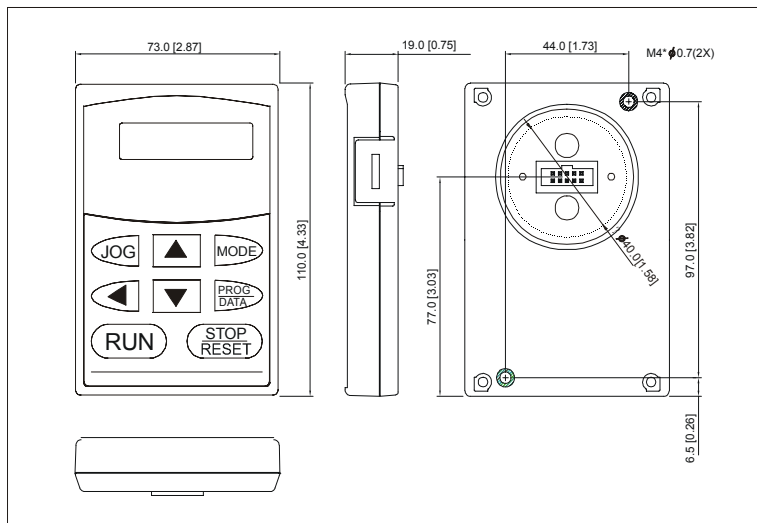

Unit: mm [inch]

## 3.1.4 Reference Table for the LED Display of the Digital Keypad

Digit	0	1	2	3	4	5	6	7	8	9
LED Display	0	1	2	3	4	5	6	7	8	9

English alphabet	A	b	Cc	d	E	F	G	Hh	li	Jj
LED Display	A	b	Cc	d	E	F	G	Hh	li	Jj



English alphabet	K	L	n	Oo	P	q	r	S	Tt	U
LED Display	K	L	n	Oo	P	q	r	S	Tt	U

English alphabet	v	Y	Z							
LED Display	v	Y	Z							





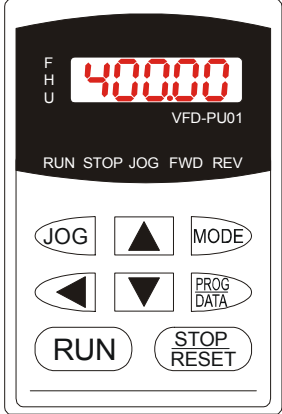

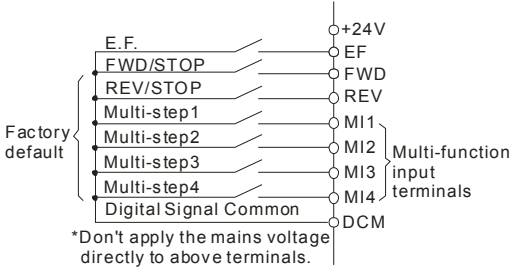
## 3.2 Operation Method

The operation method can be set via communication, digital keypad and control terminals. Please choose a suitable method depending on application and operation rule.

Operation Method	Frequency Source	Operation Command Source
Operate from the communication	Refer to the communication address 2001H setting for details. (Parameter setting: Pr.02-00=03)	Refer to the communication address 2000H setting for details. (Parameter setting: Pr.02-01=03/04)
VFD-PU01 keypad		
		
Operate from external signal		
	MI1-DCM (Set Pr.04-00=13) MI2-DCM (Set Pr.04-01=14)	FWD-DCM (Set to FWD/STOP) REV-DCM (Set to REV/STOP)

### 3.3 Trial Run

you can perform a trial run by using digital keypad with the following steps. The factory setting of the operation source is from the keypad (Pr.02-01=00).

1. After applying power, verify that LED "F" is on and the display shows 60.00Hz.
2. Setting frequency to about 5Hz by using  key.
3. Pressing  key for forward running. And if you want to change to reverse running, you should press  key in  page. And if you want to decelerate to stop, please press  key.
4. Check following items:
  - *Check if the motor direction of rotation is correct.*
  - *Check if the motor runs steadily without abnormal noise and vibration.*
  - *Check if acceleration and deceleration are smooth.*

If the results of trial run are normal, please start the formal run.

#### **NOTE**

1. Stop running immediately if any fault occurs and refer to the troubleshooting guide for solving the problem.
2. Do NOT touch output terminals U, V, W when power is still applied to L1/R, L2/S, L3/T even when the AC motor drive has stopped. The DC-link capacitors may still be charged to hazardous voltage levels, even if the power has been turned off.
3. To avoid damage to components, do not touch them or the circuit boards with metal objects or your bare hands.

This page intentionally left blank.

## **Chapter 4 Parameters**

---

The VFD-G parameters are divided into 10 groups by property for easy setting. In most applications, the user can finish all parameter settings before start-up without the need for re-adjustment during operation.

The 10 groups are as follows:

Group 0: User Parameters

Group 1: Basic Parameters

Group 2: Operation Method Parameters

Group 3: Output Function Parameters

Group 4: Input Function Parameters

Group 5: Multi-Step Speed Parameters

Group 6: Protection Function Parameters

Group 7: AC Drive and Motor Parameters

Group 8: Special Parameters

Group 9: Communication Parameters

Group 10: PID Control Parameters

## 4.1 Summary of Parameter Settings

✕: The parameter can be set during operation.

### Group 0 User Parameters

Parameter	Functions	Settings	Factory Setting	Customer
00-00	Software Version	Read only		
00-01	AC Drive Status Indication 1	00: No Fault occurred 01: oc (over current) 02: ov(over voltage) 03: oH(over temperature) 04: oL(overload) 05: oL1(electronic thermal relay) 06: EF(external Fault) 07: occ(AC drive IGBT fault) 08: CF3(CPU failure) 09: HPF(Hardware Protection Failure) 10: ocA(current exceed during Acceleration) 11: ocd(current exceed during Deceleration) 12: ocn(current exceed during Steady State) 13: GFF(Ground Fault) 14: Lv(Low voltage) 15: CF1(abnormal input data) 16: CF2(abnormal output data) 17: bb(Base Block) 18: oL2(over load2) 19: Reserved 20: codE(software or password protection) 21: EF1(external Emergency Stop) 22: PHL(phase loss) 23: Lc (Low Current) 24: FbL(Feedback Loss) 25: Reserved 26: FANP (Fan Power Fault) 27: FF1 (Fan 1 Fault) 28: FF2 (Fan 2 Fault) 29: FF3 (Fan 3 Fault) 30: FF123 (Fan 1, 2, 3 Fault) 31: FF12 (Fan 1, 2 Fault) 32: FF13 (Fan 1, 3 Fault) 33: FF23 (Fan 2, 3 Fault) 34: Fv (Gate Drive Low Voltage Protect) 35~40: Reserved 41: HPF1 (GFF hardware error) 42: HPF2 (CC,OC hardware error)	Read	

Parameter	Functions	Settings	Factory Setting	Customer
		43: HPF3 (OC hardware error) 44: HPF4 (OV hardware error) 45: CF3.3 (U-phase error) 46: CF3.4 (V-phase error) 47: CF3.5 (W-phase error) 48: CF3.6 (OV or LV) 49: CF3.7 (Isum error) 50: CF3.8 (Temperature sensor error)		
00-02	AC Drive Status Indication 2	Bit 0~1: 00: Run led is off and stop led is on. 01: Run led is blink and stop led is on. 10: Run led is on and stop led is blink. 11: Run led is on and stop led is off. Bit 2: 1: Jog on. Bit 3~4: 00: Rev led is off and FWD led is on. 01: Rev led is blink and FWD led is on. 10: Rev led is on and FWD led is blink. 11: Rev led is on and FWD led is off. Bit 5-7: Reserved Bit 8: Master frequency source via communication interface Bit 9: Master frequency source via analog Bit10: Running command via communication interface Bit11: Parameter locked Bit12~15: Reserved	Read	
00-03	Frequency Setting (F) or Closed Loop Control Setting Point	Read only	Read	
00-04	Output Frequency (H)	Read only	Read	
00-05	Output Current (A)	Read only	Read	
00-06	DC-BUS Voltage (U)	Read only	Read	
00-07	Output Voltage (E)	Read only	Read	
00-08	Output Power Factor (n)	Read only	Read	
00-09	Output Power (kW)	Read only	Read	
00-10	Feedback Signal Actual Value	Read only	Read	
00-11	Feedback Signal (%)	Read only	Read	
00-12	User Target Value (Low bit) uL 0-99.99	Read only	Read	

Parameter	Functions	Settings	Factory Setting	Customer
00-13	User Target Value (High bit) uH 0-9999	Read only	Read	
00-14	PLC Time	Read only	Read	
00-15	Output Reactive Power (KVAR)	Read only	Read	

### Group 1 Basic Parameters

Parameter	Functions	Settings	Factory Setting	Customer
01-00	Maximum Output Frequency	50.00~160.00Hz	60.00	
01-01	Maximum Voltage Frequency (Base Frequency)	0.10~160.00 Hz	60.00	
01-02	Maximum Output Voltage	0.2V ~ 510.0V	440.0	
01-03	Mid-point Frequency	0.10~120 Hz	3.00	
01-04	Mid-point Voltage	0.2V~510.0V	11.0	
01-05	Minimum Output Frequency	0.10~20.00 Hz	3.00	
01-06	Minimum Output Voltage	0.2V~100.0V	11.0	
01-07	Upper Bound Frequency	0.00~160.00 Hz	60.00	
01-08	Lower Bound Frequency	0.00~160.00 Hz	0.00	
↗01-09	Acceleration Time 1	0.1~3600.0 Sec	10.0/ 60.0	
↗01-10	Deceleration Time 1	0.1~3600.0 Sec	10.0/ 60.0	
↗01-11	Acceleration Time 2	0.1~3600.0 Sec	10.0/ 60.0	
↗01-12	Deceleration Time 2	0.1~3600.0 Sec	10.0/ 60.0	
↗01-13	Acceleration Time 3	0.1~3600.0 Sec	10.0/ 60.0	
↗01-14	Deceleration Time 3	0.1~3600.0 Sec	10.0/ 60.0	
↗01-15	Acceleration Time 4	0.1~3600.0 Sec	10.0/ 60.0	
↗01-16	Deceleration Time 4	0.1~3600.0 Sec	10.0/ 60.0	

Parameter	Functions	Settings	Factory Setting	Customer
↗01-17	JOG Acceleration Time	0.1~3600.0 Sec	10.0/ 60.0	
↗01-18	JOG Deceleration Time	0.1~3600.0 Sec	10.0/ 60.0	
↗01-19	JOG Frequency	0.0 Hz~160.00 Hz	6.00	
01-20	S Curve Delay Time in Accel	0.00~2.50sec	0.00	
01-21	S Curve Delay Time in Decel	0.00~2.50sec	0.00	
↗01-22	Modulation Index	0.90~1.20	1.00	
01-23	Accel/Decel Time Unit	00: Unit is 1 Sec 01: Unit is 0.1 Sec 02: Unit is 0.01 Sec	01	

## Group 2 Operation Method Parameters

Parameter	Functions	Settings	Factory Setting	Customer
↗02-00	Source of Frequency Command	00: via keypad 01: via analog input AI1 02: via analog input AI2 03: via RS485 serial communication 04: via External Reference	00	
↗02-01	Source of Operation Command	00: Controlled by the digital keypad 01: Controlled by the external terminals, keypad STOP enabled. 02: Controlled by external terminals, keypad STOP disabled. 03: Controlled by the RS-485 communication interface, keypad STOP enabled. 04: Controlled by the RS-485 communication interface, keypad STOP disabled.	00	
02-02	Stop Method	00: Stop = ramp to stop, E.F. (External Fault) = coast to stop 01: Stop = coast to stop, E.F. = coast to stop 02: Stop = ramp to stop, E.F. = ramp to stop 03: Stop = coast to stop, E.F. = ramp to stop	00	
↗02-03	PWM Carrier Frequency Selections	7.5~10HP: 4000~6000Hz 15~30HP: 3000~6000Hz 40~125HP: 2000~6000Hz 150~300HP: 2000~4000Hz	6000 6000 4000 4000	



Parameter	Functions	Settings	Factory Setting	Customer
02-04	Forward/Reverse Enable	00: Forward enabled 01: Reverse disabled 02: Forward disabled	00	
02-05	2-wire/3-wire Operation Control Modes	00: 2-wire: FWD/STOP, REV/STOP 01: 2-wire: FWD/REV, RUN/STOP 02: 3-wire operation	00	
02-06	Line Start Lockout	00: Disabled 01: Enabled	01	
02-07	Reserved			
↗02-08	Start-up Display Selection	Bit0~1: 00 = F LED 01 = H LED 10 = U LED (special display) 11 = Fwd / Rev Bit2: 0 = Fwd LED / 1 = Rev LED Bit3~5: 000 = 1st 7-step 001 = 2nd 7-step 010 = 3rd 7-step 011 = 4th 7-step 100 = 5th 7-step Bit6~7: Reserved	00	
↗02-09	Special Display	00: A displays output current of AC drive 01: U displays DC-Bus voltage of AC drive 02: E displays RMS of output voltage 03: P displays feedback Signal 04: PLC display auto procedure state	00	
↗02-10	User Defined Coefficient	0.01~160.00	1.00	
↗02-11	Flying Start	00: Disabled 01: Enable (Dc braking disabled)	00	
↗02-12	Flying Start Frequency	00: Trace from master frequency command 01: Trace from maximum setting frequency 01-00	00	
↗02-13	Master Frequency Memory Setting	00: Do not remember the last known frequency 01: Remember the last known frequency	01	

## Group 3 Output Function Parameters

Parameter	Functions	Settings	Factory Setting	Customer
03-00	Multi-function Output Terminal 1 (Relay)	00: disabled 01: Indication during operation 02: Master frequency attained 03: Zero Speed (including shutdown) 04: Over-torque 05: External Fault 06: Low voltage detection 07: Operation Mode indication 08: Fault indication 09: Master Frequency Attained 1 10: Master Frequency Attained 2 11: Over Temperature indication 12: Drive Ready 13: External Emergency Stop (EF1) 14: Software Braking Output 15: OL or OL1 Overload Warning 16: Low Current Indication 17: PID Feedback Error Indication 18: PLC Program Running 19: PLC Program Step Completed 20: PLC Program Completed 21: PLC Operation Paused	01	
03-01	Reserved			
03-02	Master Frequency Attained 1	0.00~160.00 Hz	0.00	
03-03	Master Frequency Attained 2	0.00~160.00 Hz	0.00	
03-04	DC Fan Control	00: Fan runs on power up. 01: Fan begins upon a RUN command. Fan stops 1 minute after a STOP command. 02: Fan begins upon a RUN command. Fan stops after a STOP command 03: Fan is controlled by temperature. Fan will be started at approximate 60°C.	00	
03-05	Analog Output Signal 1	00: Output frequency 01: Output current	00	
03-06	Analog Output Signal 2	02: Output voltage 03: Frequency command 04: Power factor loading	01	
↗03-07	Analog Output Gain 1	01~200%	100	
↗03-08	Analog Output Gain 2	01~200%	100	
03-09	Analog Output 2 Selection	00: 0~20mA 01: 4~20mA	01	

## Group 4 Input Function Parameters

Parameter	Functions	Settings	Factory Setting	Customer
04-00	Multi-function Input Terminal 1	00: disabled	01	
04-01	Multi-function Input Terminal 2	01: Multi-Speed terminal 1 02: Multi-Speed terminal 2 03: Multi-Speed terminal 3	02	
04-02	Multi-function Input Terminal 3	04: Multi-Speed terminal 4 05: Reset (NO)	03	
04-03	Multi-function Input Terminal 4	06: Reset (NC) 07: Jog operation (JOG) 08: Accel/Decel disabled 09: 1st and 2nd Accel/Decel selection 10: 3rd and 4th Accel/Decel selection 11: B.B. (NO) input 12: B.B. (NC) input 13: Increase Frequency 14: Decrease Frequency 15: Emergency stop (NO) 16: Emergency stop (NC) 17: KEYPAD(open), EXT(close) 18: PID disable 19: Run PLC Program 20: Pause PLC Program 21: 1st Output Frequency Gain (Pr.04-30) 22: 2nd Output Frequency Gain (Pr.04-31) 23: 3rd Output Frequency Gain (Pr.04-32)	04	
04-04	Digital Input Terminal Response Time	01~20	01	
04-05	Minimum AI1 Analog Input	0 ~ 100%	0	
04-06	Maximum AI1 Analog Input	0 ~ 100%	100	
04-07	Minimum Output that corresponds to AI1	0.00~100.00%	0.00	
04-08	Maximum Output that corresponds to AI1	0.00~100.00%	100.00	
04-09	Minimum AI2 Analog Input	0 ~ 100%	0	
04-10	Maximum AI2 Analog Input	0 ~ 100%	100	
04-11	Minimum Output that corresponds to AI2	0.0~100.0%	0.00	
04-12	Maximum Output that corresponds to AI2	0.0~100.0%	100.00	
↗04-13	1st AI1 Gain	0.0~100.0%	100.0	

Parameter	Functions	Settings	Factory Setting	Customer
↗04-14	2nd AI1 Gain	0.0~100.0%	100.0	
↗04-15	3rd AI1 Gain	0.0~100.0%	100.0	
↗04-16	4th AI1 Gain	0.0~100.0%	100.0	
↗04-17	5th AI1 Gain	0.0~100.0%	100.0	
↗04-18	1st AI2 Gain	0.0~100.0%	100.0	
↗04-19	2nd AI2 Gain	0.0~100.0%	100.0	
↗04-20	3rd AI2 Gain	0.0~100.0%	100.0	
↗04-21	4th AI2 Gain	0.0~100.0%	100.0	
↗04-22	5th AI2 Gain	0.0~100.0%	100.0	
04-23	Analog Input Delay AI1	0.00~10.00 Sec	0.50	
04-24	Analog Input Delay AI2	0.00~10.00 Sec	0.50	
04-25	Summation of External Frequency Sources	00: Disabled 01: AI1*( AI1 Gain) + AI2*( AI2 Gain) 02: AI1*( AI1 Gain) - AI2*( AI2 Gain) 03: AI1*( AI1 Gain) * AI2 *( AI2 Gain) 04: Reserved 05: Communication master frequency+AI1*( AI1 Gain) 06: Communication master frequency+AI2*( AI2 Gain) 07: Max (AI1*( AI1 Gain), AI2*( AI2 Gain))	00	
04-26	1st AI Frequency Gain	0.00: Disabled 0.01~160.00 Hz	0.00	
04-27	2nd AI Frequency Gain	0.00: Disabled 0.01~160.00 Hz	0.00	
04-28	3rd AI Frequency Gain	0.00: Disabled 0.01~160.00 Hz	0.00	
04-29	4th AI Frequency Gain	0.00: Disabled 0.01~160.00 Hz	0.00	
04-30	1st Out Frequency Gain	0.0 to 200.0%	100.0	
04-31	2nd Out Frequency Gain	0.0 to 200.0%	100.0	
04-32	3rd Out Frequency Gain	0.0 to 200.0%	100.0	

**Group 5 Multi-step Speed Parameters**

Parameter	Functions	Settings	Factory Setting	Customer
↗05-00	1st Step Speed Frequency	0.00~160.00 Hz	0.00	
↗05-01	2nd Step Speed Frequency	0.00~160.00 Hz	0.00	
↗05-02	3rd Step Speed Frequency	0.00~160.00 Hz	0.00	
↗05-03	4th Step Speed Frequency	0.00~160.00 Hz	0.00	
↗05-04	5th Step Speed Frequency	0.00~160.00 Hz	0.00	
↗05-05	6th Step Speed Frequency	0.00~160.00 Hz	0.00	
↗05-06	7th Step Speed Frequency	0.00~160.00 Hz	0.00	
↗05-07	8th Step Speed Frequency	0.00~160.00 Hz	0.00	
↗05-08	9th Step Speed Frequency	0.00~160.00 Hz	0.00	
↗05-09	10th Step Speed Frequency	0.00~160.00 Hz	0.00	
↗05-10	11th Step Speed Frequency	0.00~160.00 Hz	0.00	
↗05-11	12th Step Speed Frequency	0.00~160.00 Hz	0.00	
↗05-12	13th Step Speed Frequency	0.00~160.00 Hz	0.00	
↗05-13	14th Step Speed Frequency	0.00~160.00 Hz	0.00	
↗05-14	15th Step Speed Frequency	0.00~160.00 Hz	0.00	
05-15	PLC Mode	00: Disable PLC Operation 01: Execute one program cycle 02: Continuously execute program cycles 03: Execute one program cycle step by step 04: Continuously execute program cycles step by step	00	
05-16	PLC Forward/ Reverse Motion	00 to 32767 (00: FWD 01: REV)	00	
05-17	Time Duration Step 1	0.0 to 65500 Sec / 0.0~6550.0 Sec	0.0	
05-18	Time Duration Step 2	0.0 to 65500 Sec / 0.0~6550.0 Sec	0.0	
05-19	Time Duration Step 3	0.0 to 65500 Sec / 0.0~6550.0 Sec	0.0	

Parameter	Functions	Settings	Factory Setting	Customer
05-20	Time Duration Step 4	0.0 to 65500 Sec / 0.0~6550.0 Sec	0.0	
05-21	Time Duration Step 5	0.0 to 65500 Sec / 0.0~6550.0 Sec	0.0	
05-22	Time Duration Step 6	0.0 to 65500 Sec / 0.0~6550.0 Sec	0.0	
05-23	Time Duration Step 7	0.0 to 65500 Sec / 0.0~6550.0 Sec	0.0	
05-24	Time Duration Step 8	0.0 to 65500 Sec / 0.0~6550.0 Sec	0.0	
05-25	Time Duration Step 9	0.0 to 65500 Sec / 0.0~6550.0 Sec	0.0	
05-26	Time Duration Step 10	0.0 to 65500 Sec / 0.0~6550.0 Sec	0.0	
05-27	Time Duration Step 11	0.0 to 65500 Sec / 0.0~6550.0 Sec	0.0	
05-28	Time Duration Step 12	0.0 to 65500 Sec / 0.0~6550.0 Sec	0.0	
05-29	Time Duration Step 13	0.0 to 65500 Sec / 0.0~6550.0 Sec	0.0	
05-30	Time Duration Step 14	0.0 to 65500 Sec / 0.0~6550.0 Sec	0.0	
05-31	Time Duration Step 15	0.0 to 65500 Sec / 0.0~6550.0 Sec	0.0	
05-32	Time Unit Settings	00: 1 Sec 01: 0.1 Sec	00	

#### Group 6 Protection Function Parameters

Parameter	Functions	Settings	Factory Setting	Customer
06-00	Over-voltage Stall Prevention	660.0V~820.0VDC 00: Disabled	780.0	
06-01	Over-current Stall Prevention during Acceleration	20~250% 00: Disabled	150%	
06-02	Over-current Stall Prevention during operation	20~250% 00: Disabled	150%	
06-03	Over-torque Detection Selection	00: Over-torque detection disabled. 01: Over-torque detection enabled during constant speed operation (OL2), and operation continues. 02: Over-torque detection enabled during constant speed operation (OL2), and operation halted. 03: Over-torque detection enabled during operation (OL2), and operation continues. 04: Over-torque detection enabled during operation (OL2), and operation halted.	00	
06-04	Over-torque Detection Level	30~150%	110	
06-05	Over-torque Detection Time	0.1~60.0 Sec	0.1	

Parameter	Functions	Settings	Factory Setting	Customer
06-06	Electronic Thermal Relay Selection	00: Operate disabled. 01: Operate with a standard motor. 02: Operate with a special motor.	02	
06-07	Electronic Thermal Characteristic	30~600 Sec	60	
06-08	Low Current Detection Level	00~100% (00 disabled)	00	
06-09	Low Current Detection Time	0.1~ 3600.0 Sec	10.0	
06-10	Low Current Detection Treatment	00: Warn and Ramp to stop 01: Warn and Coast to stop 02: Warn and keep operating	01	
06-11	Present Fault Record	00: No Fault	00	
06-12	Second Most Recent Fault Record	01: Oc (over-current) 02: Ov (over-voltage)	00	
06-13	Third Most Recent Fault Record	03: OH (over temperature) 04: OL (over load) 05: oL1 (over load 1)	00	
06-14	Fourth Recent Fault Record	06: EF (external fault) 07: Occ (IGBT module is abnormal) 08: CF3 (driver's internal circuitry is abnormal) 09: HPF (hardware protection failure) 10: OcA (over-current during acceleration) 11: Ocd (over-current during deceleration) 12: Ocn (over-current during steady state operation) 13: GFF(Ground Fault) 14: Lv (Low voltage) 15: CF1 (CPU READ failure) 16: CF2 (CPU WRITE failure) 17: bb (Base Block) 18: OL2 (over load2) 19: Reserved 20: Code (software/password protection) 21: EF1 (Emergency stop) 22: PHL (phase-loss) 23: Lc (Low Current) 24: FbL(Feedback Loss) 25: Reserved 26: FANP (Fan Power Fault) 27: FF1 (Fan 1 Fault) 28: FF2 (Fan 2 Fault) 29: FF3 (Fan 3 Fault) 30: FF123 (Fan 1, 2, 3 Fault)	00	

Parameter	Functions	Settings	Factory Setting	Customer
		31: FF12 (Fan 1, 2 Fault) 32: FF13 (Fan 1, 3 Fault) 33: FF23 (Fan 2, 3 Fault) 34: Fv (Gate Drive Low Voltage Protect) 35~40: Reserved 41: HPF1 (GFF hardware error) 42: HPF2 (CC,OC hardware error) 43: HPF3 (OC hardware error) 44: HPF4 (OV hardware error) 45: CF3.3 (U-phase error) 46: CF3.4 (V-phase error) 47: CF3.5 (W-phase error) 48: CF3.6 (OV or LV) 49: CF3.7 (Isum error) 50: CF3.8 (Temperature sensor error)		
06-15	Parameter Reset	00~65535 09: Reset parameters (50Hz, 380) 10: Reset parameters (60Hz, 440)	00	
06-16	Parameter Protection Password Input	00~65535	00	
06-17	Parameter Protection Password Setting	00~65535 00: No password protection	00	

### Group 7 AC Drive and Motor Parameters

Parameter	Functions	Settings	Factory Setting	Customer
07-00	Identity Code of AC Drive	Display by model type	##	
07-01	Rated Current of AC Drive	Display by model type	##	
↗07-02	Full-load Current of Motor	30~120%	100%	
↗07-03	No-load Current of Motor	1~99%	30%	
↗07-04	Auto Slip Compensation Gain	0.0~3.0	0.0	
07-05	Rated Slip Frequency of Motor	0.00~20.00Hz	0.00	
↗07-06	Auto Torque Compensation Gain	0.0~10.0	0.0	
↗07-07	Torque Compensation Gain by Manually	0.0~10.0	0.0	



Parameter	Functions	Settings	Factory Setting	Customer
07-08	Calculate Total Running Time of the Motor (Min)	00 to 1439 Min	00	
07-09	Calculate Total Running Time of the Motor (Day)	00 to 65535 Day	00	
07-10	Electric Bill for One Time	Read Only	Read	
07-11	Accumulated Electric Bill (per currency unit)	Read Only	Read	
07-12	Accumulated Electric Bill (per 10 <sup>4</sup> currency unit)	Read Only	Read	
07-13	Electric Rate (per currency unit)	0.01 to 655.35	0.6	

## Group 8 Special Parameters

Parameter	Functions	Settings	Factory Setting	Customer
08-00	DC Braking Current Level	00~100%	00	
08-01	DC Braking Time during Start-up	0.0~60.0 Sec	0.0	
08-02	DC Braking Time during Stopping	0.00~60.00 Hz	0.0	
08-03	Start-point for DC Braking	0.00~160.00 Hz	0.00	
08-04	Momentary Power Loss Operation Selection	00: Disable 01: Trace from top downward 02: Trace from bottom upward	00	
08-05	Maximum Allowable Power Loss Time	0.1~5.0 Sec	2.0	
08-06	Speed Search Time	0.1~5.0 Sec	0.5	
08-07	Maximum Speed Search Current	30~150%	110	
08-08	BB speed search method	00: Trace from top downward 01: Trace from bottom upward	00	
08-09	Auto Restart Times after Fault	00~10	00	
08-10	Auto Restart Time after Fault	00 to 60000 sec	600	

Parameter	Functions	Settings	Factory Setting	Customer
08-11	Operation Frequency Inhibition 1 UP	0.00~160.00 Hz	0.00	
08-12	Operation Frequency Inhibition 1 DOWN	0.00~160.00 Hz	0.00	
08-13	Operation Frequency Inhibition 2 UP	0.00~160.00 Hz	0.00	
08-14	Operation Frequency Inhibition 2 DOWN	0.00~160.00 Hz	0.00	
08-15	Operation Frequency Inhibition 3 UP	0.00~160.00 Hz	0.00	
08-16	Operation Frequency Inhibition 3 DOWN	0.00~160.00 Hz	0.00	
08-17	Automatic Energy-saving	00: Energy-saving operation disabled 01: Energy-saving operation enabled	00	
08-18	Automatic Voltage Regulation (AVR)	00: AVR function enabled 01: AVR function disabled 02: AVR function disabled for deceleration	00	
↗08-19	Software Setting of the Braking Level (the action level of the braking resistor)	740V~820VDC 00:Disabled	760	
↗08-20	Vibration Compensation Factor	00~1000	00	

### Group 9 Communication Parameters

Parameter	Functions	Settings	Factory Setting	Customer
↗09-00	Communication Address	01-254 00:Disabled	01	
↗09-01	Transmission Speed (Baud Rate)	00: Baud rate 4800 01: Baud rate 9600 02: Baud rate 19200 03: Baud rate 38400	01	
↗09-02	Transmission Fault Treatment	00: Warn and keep operating 01: Warn and RAMP to stop 02: Warn and COAST to stop 03: No warning and no display	03	
09-03	Over Time Detection during Transmission	00: Disabled 01: Enabled	00	
09-04	Communication Format	00: 7-bit for ASCII 01: 8-bit for ASCII 02: 8-bit for RTU	00	

Parameter	Functions	Settings	Factory Setting	Customer
09-05	Even/Odd Parity and Stopping Parity Setting	00: None parity + 2 stop bit 01: Even parity + 2 stop bit 02: Odd parity + 2 stop bit 03: None parity + 1 stop bit 04: Even parity + 1 stop bit 05: Odd parity + 1 stop bit	00	
↗09-06	Communication Operation Command 1	Bit0~1: 00: Disable 01: Stop 10: Start-up 11: JOG start-up Bit2~3: Reserved Bit4~5: 00: No function 01: FWD command 10: REV command 11: Change direction command Bit6~7: 00: 1st step accel/decel speed 01: 2nd step accel/decel speed 10: 3rd step accel/decel speed 11: 4th step accel/decel speed Bit8~11: 0000: Master speed 0001: 1st step speed 0010: 2nd step speed 0011: 3rd step speed 0100: 4th step speed 0101: 5th step speed 0110: 6th step speed 0111: 7th step speed 1000: 8th step speed 1001: 9th step speed 1010: 10th step speed 1011: 11th step speed 1100: 12th step speed 1101: 13th step speed 1110: 14th step speed 1111: 15th step speed Bit12: Select Bit6~11 function Bit13~15 Reserved	00	
↗09-07	Communication Frequency Setting	0~160.00Hz	60.00	
↗09-08	Communication Operation Command 2	Bit0: 1: EF ON Bit1: 1: Reset Bit2: 0: BB OFF, 1: BB ON Bit3~15: Reserved	00	

## Group 10 PID Control Parameters

Parameter	Functions	Settings	Factory Setting	Customer
10-00	Input Terminal for PID Feedback	00: Disabled 01: Input via AI1 02: Input via AI2 03: Input via External Reference	00	
10-01	PID Control Detection Signal Reference	1.0-6550.0	1000.0	
10-02	PID Feedback Control Method	00: Normal (Err=SP-FB) 01: Inverse (Err=FB-SP)	00	
10-03	Proportional Gain (P)	0.0~10.0	1.0	
10-04	Integral Time (I)	0.00~100.00 Sec	1.00	
10-05	Differential Time (D)	0.00~1.00 Sec	0.00	
10-06	Upper Bound for Integral Control	00~200%	100	
10-07	Primary Low Pass Filter Time	0.0~2.5 Sec	0.0	
10-08	PID Feedback Signal Range	0.01 to 10-01	600.0	
10-09	PID Feedback Signal Fault Treatment Time	0.0~3600.0 Sec 0.0: Disabled	0.0	
↗10-10	PID Feedback Signal Fault Treatment	00: Warn and RAMP stop 01: Warn and COAST stop 02: Warn and keep operating	01	
10-11	V/F Curve Selection	00: Determined by group 01 01: 1.5 power curve 02: 1.7 power curve 03: 2 power curve 04: 3 power curve	00	

## 4.2 Parameter Settings for Applications

### Speed Search

Applications	Purpose	Functions	Related Parameters
Windmill, winding machine, fan and all inertia load	Restart free-running motor	Before the free-running motor is completely stopped, it can be restarted without detecting motor speed. The AC motor drive will auto search motor speed and will accelerate when its speed is the same as the motor speed.	02-11 02-12 08-04 08-05 08-06 08-07

### DC Brake before Running

Applications	Purpose	Functions	Related Parameters
When e.g. windmills, fans and pumps rotate freely by wind or flow without applying power	Keep the free-running motor at standstill.	If the running direction of the free-running motor is not steady, please execute DC brake before start-up.	08-00 08-01

### Energy Saving

Applications	Purpose	Functions	Related Parameters
Punching machines and precision machinery	Energy saving and less vibrations	Energy saving when the AC motor drive runs at constant speed, yet full power acceleration and deceleration. For precision machinery it also helps to lower vibrations.	08-17

### Multi-step Operation

Applications	Purpose	Functions	Related Parameters
Conveying machinery	Cyclic operation by multi-step speeds.	To control 15-step speeds and duration by simple contact signal.	04-00~04-03 05-00~05-14

### Switching acceleration and deceleration time

Applications	Purpose	Functions	Related Parameters
Auto turntable for conveying machinery	Switching acceleration and deceleration times by external signal	Switching the multi-step acceleration/deceleration by external signals. When an AC motor drive drives two or more motors, it can reach high-speed but still start and stop smoothly.	01-09~01-16 04-00~04-03

## Overheat Warning

Applications	Purpose	Functions	Related Parameters
Air conditioner	Safety measure	When the AC motor drive overheats, it uses a thermal sensor to generate a overheat warning.	03-00 04-00~04-03

## Two-wire/three-wire

Applications	Purpose	Functions	Related Parameters
General application	To run, stop, forward and reverse by external terminals		02-05 04-00~04-03

## Operation Command

Applications	Purpose	Functions	Related Parameters
General application	Selecting the source of control signal	Selection of AC motor drive control by external terminals, digital keypad or RS485.	02-01 04-00~04-03

## Frequency Hold

Applications	Purpose	Functions	Related Parameters
General application	Acceleration/ deceleration pause	Hold output frequency during Acceleration/deceleration	04-00~04-03

## Auto Restart after Fault

Applications	Purpose	Functions	Related Parameters
Air conditioners, remote pumps	For continuous and reliable operation without operator intervention	The AC motor drive can be restarted/reset automatically up to 10 times after a fault occurs.	08-09 08-10

**Emergency Stop by DC Brake**

Applications	Purpose	Functions	Related Parameters
High-speed rotors	Emergency stop without brake resistor	AC motor drive can use DC brake for emergency stop when a quick stop is needed without brake resistor. When used often, take motor cooling into consideration.	08-00 08-02 08-03

**Over-torque Setting**

Applications	Purpose	Functions	Related Parameters
Pumps, fans and extruders	To protect machines and to have continuous/reliable operation	The over-torque detection level can be set. Once OC stall, OV stall and over-torque occurs, the output frequency will be adjusted automatically. It is suitable for machines like fans and pumps that require continuous operation.	06-03~06-05

**Upper/Lower Limit Frequency**

Applications	Purpose	Functions	Related Parameters
Pump and fan	Control the motor speed within upper/lower limit	When user cannot provide upper/lower limit, gain or bias from external signal, it can be set individually in AC motor drive.	01-07 01-08

**Skip Frequency Setting**

Applications	Purpose	Functions	Related Parameters
Pumps and fans	To prevent machine vibrations	The AC motor drive cannot run at constant speed in the skip frequency range. Three skip frequency ranges can be set. It is used to smooth vibration at certain frequencies.	08-11~08-16

**Carrier Frequency Setting**

Applications	Purpose	Functions	Related Parameters
General application	Low noise	The carrier frequency can be increased when required to reduce motor noise.	02-03

**Output Signal during Running**

Applications	Purpose	Functions	Related Parameters
General application	Provide a signal for running status	Signal available to stop braking when the AC motor drive is running. (This signal will disappear when the AC motor drive is free-running.)	03-00

**Output Signal in Zero Speed**

Applications	Purpose	Functions	Related Parameters
General application	Provide a signal for running status	When the output frequency is lower than the min. output frequency, a signal is given for external system or control wiring.	03-00

**Output Signal at Master Frequency**

Applications	Purpose	Functions	Related Parameters
General application	Provide a signal for running status	When the output frequency is at the master frequency (by frequency command), a signal is given for external system or control wiring (frequency attained).	03-00

**Output signal for Over-torque**

Applications	Purpose	Functions	Related Parameters
Pumps, fans and extruders	To protect machines and to have continuous/reliable operation	When over-torque is detected, a signal is given to prevent machines from damage.	03-00 06-03 06-04 06-05

**Output Signal for Low Voltage**

Applications	Purpose	Functions	Related Parameters
General application	Provide a signal for running status	When low voltage is detected, a signal is given for external system or control wiring.	03-00

**Output Signal at Desired Frequency**

Applications	Purpose	Functions	Related Parameters
General application	Provide a signal for running status	When the output frequency is at the desired frequency (by frequency command), a signal is sent by an external system or control wiring.	03-00 03-02 03-03



**Output Signal for Base Block**

<b>Applications</b>	<b>Purpose</b>	<b>Functions</b>	<b>Related Parameters</b>
General application	Provide a signal for running status	When executing Base Block, a signal is sent by an external system or control wiring.	03-00

**Overheat Warning for Heat Sink**

<b>Applications</b>	<b>Purpose</b>	<b>Functions</b>	<b>Related Parameters</b>
General application	For safety	When heat sink is overheated, it will send a signal by an external system or control wiring.	03-00

**Multi-function Analog Output**

<b>Applications</b>	<b>Purpose</b>	<b>Functions</b>	<b>Related Parameters</b>
General application	Display running status	The value of frequency, output current/voltage can be read by adding a frequency meter or voltage/current meter.	03-05~03-09

### 4.3 Description of Parameter Settings

#### Group 0: User Parameters

**⚡**: This parameter can be set during operation.

**00 - 00** Software Version

Factory setting: Read Only

 This parameter displays the software version of AC drive.

**00 - 01** AC Drive Status Indication 1

Factory setting: Read Only

 This parameter displays the AC drive status.

Code	AC Drive Status	Explanation
00	No fault occurred	
01	oc	over current
02	ov	over voltage
03	oH	over temperature
04	oL	overload
05	oL1	electronic thermal relay
06	EF (external fault)	EF-DCM is closed
07	occ (AC drive IGBT fault )	IGBT short circuit protection
08	CF3 (CPU failure)	Abnormal A/D reading during self-check
09	HPF (hardware protection failure)	Hardware protection function activated during self-check.
10	ocA (over current during acceleration)	Output current exceeds protection level during acceleration
11	ocd (over current during deceleration)	Output current exceeds protection level during deceleration
12	Ocn (over current during steady state)	Output current exceeds protection level during steady state operation.
13	GFF (ground fault)	Ground fault protection feature activated
14	Lv (under voltage)	Low input voltage
15	CF1	EEPROM input data is abnormal
16	CF2	EEPROM output data is abnormal
17	bb (base block)	BB is set and activated
18	oL2 (over load 2)	Output current exceeds rated motor current
19	Reserved	
20	codE	software or password protection
21	EF1 (external emergency stop)	EF1 (a multifunction-DCM is enabled)

Code	AC Drive Status	Explanation
22	PHL (phase loss)	Input power lacks phase. 3-phase input power is unbalance and exceeds specification.
23	Lc (Low Current)	Low current detection during operation.
24	FbL (Feedback Loss)	Feedback signal is abnormal.
25	Reserved	
26	FANP	Fan Power Fault
27	FF1	Fan 1 Fault
28	FF2	Fan 2 Fault
29	FF3	Fan 3 Fault
30	FF123	Fan 1, 2, 3 Fault
31	FF12	Fan 1, 2 Fault
32	FF13	Fan 1, 3 Fault
33	FF23	Fan 2, 3 Fault
34	Fv	Gate Drive Low Voltage Protect
35~40	Reserved	
41	HPF1	GFF hardware error
42	HPF2	CC,OC hardware error
43	HPF3	OC hardware error
44	HPF4	OV hardware error
45	CF3.3	U-phase error
46	CF3.4	V-phase error
47	CF3.5	W-phase error
48	CF3.6	OV or LV
49	CF3.7	Isum error
50	CF3.8	Temperature sensor error

**00 - 02** AC Drive Status Indication 2

Factory setting: Read Only

- Display Bit 0~1: 00: Run LED is off and stop led is on. (AC Drive stopping)  
01: Run LED is blink and stop led is on. (AC Drive deceleration to stop)  
10: Run LED is on and stop led is blink. (AC Drive standby)  
11: Run LED is on and stop led is off. (AC Drive running)
- Bit 2: 1: Jog on.
- Bit 3~4: 00: Rev LED is off and FWD led is on. (Forward)  
01: Rev LED is blink and FWD led is on. (Reverse to Forward)  
10: Rev LED is on and FWD led is blink. (Forward to Reverse)  
11: Rev LED is on and FWD led is off. (Reverse)
- Bit 5-7: Reserved

Bit 8: Master frequency source via communication interface

Bit 9: Master frequency source via analog

Bit10: Running command via communication interface

Bit11: Parameter locked

Bit12~15: Reserved

---

**00 - 03** Frequency Setting (F) or Closed Loop Control Setting Point

Factory setting: Read Only

 This parameter displays the frequency command set by the user.

---

**00 - 04** Output Frequency (H)

Factory setting: Read Only

 This parameter displays actual output frequency of the AC drive.

---

**00 - 05** Output Current (A)

Factory setting: Read Only

 This parameter displays actual output current of the AC drive.

---

**00 - 06** DC-BUS Voltage (U)

Factory setting: Read Only

 This parameter displays DC-BUS voltage of the AC drive.

---

**00 - 07** Output Voltage (E)

Factory setting: Read Only

 This parameter displays output voltage of the AC drive.

---

**00 - 08** Output Power Factor (n)

Factory setting: Read Only

 This parameter displays output power factor.

---

**00 - 09** Output Power (kW)

Factory setting: Read Only

 This parameter displays output power of the AC drive.

---

**00 - 10** Feedback Signal Actual Value

---

Factory setting: Read Only

---

 This parameter displays feedback signal value.

---

**00 - 11** Feedback Signal (%)

---

Factory setting: Read Only

---

 This parameter displays feedback signal value(%).

---

**00 - 12** User Target Value (Low bit) uL 0-99.99

---

Factory setting: Read Only

---

---

**00 - 13** User Target Value (High bit) uH 0-9999

---

Factory setting: Read Only

---

 User Target Value = Actual output frequency (0-04) × User Defined Multiplier (02-10).

 Maximum summed display of both parameters is 999999.99.

 When User Target Value <=99.99, 00-12=0.

---

**00 - 14** PLC Time

---

Factory setting: Read Only

---

 This parameter displays remaining time of PLC each step.

---

**00 - 15** Output Reactive Power (KVAR)

---

Factory setting: Read Only

---



 This parameter displays reactive power of AC drives.

**Group 1: Basic Parameters**



<b>01 - 00</b>	Maximum Output Frequency
Settings	50.00~160.00Hz <span style="float: right;">Factory Setting: 60.00</span>

-  This parameter determines the AC drives maximum output frequency. All master frequency commands set by the keypad or analog inputs are limited by this parameter. The analog commands (ACI1 and ACI2) may be scaled to correspond to the output frequency range. (Please refer to 04-05~04-12.)



<b>01 - 01</b>	Maximum Voltage Frequency (Base Frequency)
Settings	0.10~160.00 Hz <span style="float: right;">Factory Setting: 60.00</span>

-  This parameter sets the frequency, where the maximum output voltage (Pr. 01-02) will be reached. The output frequency may exceed this setting, but the output voltage doesn't increase beyond this point. This parameter should be set according to the rated frequency of the motor as indicated on the motor nameplate.
-  If this parameter setting is smaller than the rated frequency of the motor, nuisance over current faults or damage to the AC drive may occur.
-  If this parameter setting is greater than the rated frequency of the motor, the motor will encounter torque loss.

<b>01 - 02</b>	Maximum Output Voltage
Settings	0.2V ~ 510.0V <span style="float: right;">Factory Setting: 440.0</span>

-  This parameter determines the Maximum Output Voltage of the AC drive. This parameter setting should be set according to rated voltage of the motor as indicated on the motor nameplate. If rated voltage of the motor is 440V, this parameter must be set to 440V. If rated voltage of the motor is 380V, this parameter must be set to 380V.
-  If this setting is greater than the rated voltage of the motor, nuisance over current faults or damage to the AC drive may occur.

<b>01 - 03</b>	Mid-point Frequency
Settings	0.10~160.00 Hz <span style="float: right;">Factory Setting: 3.00</span>

-  This parameter sets the Mid-point Frequency of the V/F curve.
-  This parameter must meet the following argument. Pr.1-01 >= Pr.1-03 >= Pr.1-05.

---

<b>01 - 04</b>	Mid-point Voltage	
Settings	0.2V~510.0V	Factory Setting: 11.0

---

 This parameter sets the Mid-point Voltage of the V/F curve.

 This parameter must meet the following argument. Pr.1-02 >= Pr.1-04 >= Pr.1-06.

---

<b>01 - 05</b>	Minimum Output Frequency	
Settings	0.10~20.00 Hz	Factory Setting: 3.00

---

 This parameter sets the Minimum Output Frequency of the AC drive. This parameter must be lower than or equal to the Mid-point frequency.

---

<b>01 - 06</b>	Minimum Output Voltage	
Settings	0.2V~100.0V	Factory Setting: 11.0

---

 This parameter sets the Minimum Output Voltage of the AC Drive. The parameter must be lower than or equal to the Mid-point Voltage.

---

<b>01 - 07</b>	Upper Bound Frequency	
Settings	0.00~160.00 Hz	Factory Setting: 60.00

---

 This parameter will limit the maximum output frequency of AC drive. If slip compensation (Pr.07-02~07-05) or feedback control (Pr.10-00~10-09) are enabled, the output frequency of AC drive may exceed the Master Frequency Command, but it will continue to be limited by this parameter setting.

---

<b>01 - 08</b>	Lower Bound Frequency	
Settings	0.00~160.00 Hz	Factory Setting: 0.00





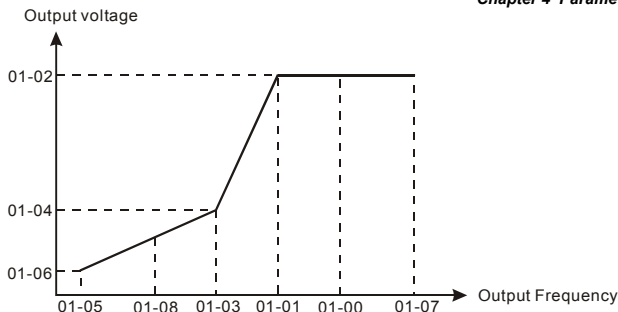

---

 This parameter will limit the minimum output frequency. Any Master Frequency Command below Pr.1-08, will result in an output equal to Pr.1-08.

 Upon a start command, the drive will accelerate from Pr.1-05 Minimum Output Frequency to the Master Frequency Command point.





01 - 09	Acceleration Time 1	Unit: 0.1sec
01 - 10	Deceleration Time 1	Unit: 0.1sec
01 - 11	Acceleration Time 2	Unit: 0.1sec
01 - 12	Deceleration Time 2	Unit: 0.1sec
01 - 13	Acceleration Time 3	Unit: 0.1sec
01 - 14	Deceleration Time 3	Unit: 0.1sec
01 - 15	Acceleration Time 4	Unit: 0.1sec
01 - 16	Deceleration Time 4	Unit: 0.1sec
01 - 17	JOG Acceleration Time	Unit: 0.1sec
01 - 18	JOG Deceleration Time	Unit: 0.1sec
Settings	0.1~3600.0 Sec	Factory Setting: 10.0/60.0

-  Factory setting for 30HP and higher models is 60.0 seconds.
-  Acceleration time is the time required for the AC drive to ramp from 0 Hz to its Maximum Output Frequency (Pr.1-00). Deceleration time is the time required for the AC drive to decelerate from Maximum Output Frequency (Pr.1-00) down to 0 Hz.
-  An Acceleration or Deceleration time that is too quickly, may cause the AC drives protection features to enable (over-current stall prevention during Accel 06-01 or over-voltage stall prevention 06-00). If this occurs, the actual Accel/Decel time will be longer than this setting.
-  Warning: An acceleration or deceleration that is too quickly, may cause excess loads on the AC drive and may permanently damage the drive.
-  If you want to decelerate the AC drive in short time period, we recommend adding an external braking module and braking resistor.
-  You can set 1st to 4th Accel/Decel time via multi-function input terminals 04-00 to 04-03.



<b>01 - 19</b>	<b>↗ JOG Frequency</b>	Unit: 0.1sec
Settings	0.0 Hz~160.00 Hz	Factory Setting: 6.00

 When the JOG function is to be utilized, users need to use the multi-function input terminals (Pr. 04-00 to 04-03 set to 07) or the JOG key on keypad. Once a JOG command is initiated, the AC drive will accelerate from the Minimum Output Frequency (Pr.01-05) to the JOG frequency (Pr.01-19).

 The accel/decel time of the JOG operation is determined by the JOG accel/decel speed (Pr.01-17 and 01-18).

 When the drive is in operation, the JOG command is disabled.

<b>01 - 20</b>	<b>S Curve Delay Time in Accel</b>	
<b>01 - 21</b>	<b>S Curve Delay Time in Decel</b>	
Settings	0.00~2.50sec	Factory Setting: 0.00

 These parameters enable the S curve. The longer the S curve time period the smoother the transition between speeds.

<b>01 - 22</b>	<b>↗ Modulation Index</b>	Unit: 0.1
Settings	0.90~1.20	Factory Setting: 1.00

 This parameter sets the ratio of the Maximum Output Voltage to the input voltage.

 The Maximum Output Voltage (Pr.01-02) is normally limited to the input voltage. With the Modulation Index parameter, the user is able to increase the output voltage beyond the incoming line voltage.

 A Modulation Index of 1, defines the Maximum Output Voltage (Pr. 1-02) is equal to the input voltage.

 A Modulation index of 1.2, defines the Maximum Output Voltage (Pr. 1-02) is 20% higher than in the input voltage. Please note, the output voltage wave form will be distorted due to harmonics and may increase torque ripple and noise in the motor.

<b>01 - 23</b>	<b>Accel/Decel Time Unit</b>	Factory Setting: 01
Settings	00: Unit is 1 Sec 01: Unit is 0.1 Sec 02: Unit is 0.01 Sec	

 This parameter sets the resolution of accel/decel time (Pr.01-09 to 01-18).



A high resolution decreases the accel/decel time range as shown in the following chart.

01-23	Accel/Decel time unit	Accel/Decel time range
00	1 Sec	1~36000 Sec
01	0.1 Sec	0.1~3600.0 Sec
02	0.01 Sec	0.01~360.00 Sec

**Group 2: Operation Method Parameters****02 - 00**  Source of Frequency Command

Factory Setting: 00

- Settings
- 00: via keypad
  - 01: via analog input AI1 (10bit)
  - 02: via analog input AI2 (10bit)
  - 03: via RS485 serial communication (RJ-11)
  - 04: via External Reference

 Settings:

- 00: Frequency command source is the keypad. User may use UP/DOWN keys to adjust the frequency command. Also if the Multi-Function Input terminals (Pr.04-00 to 04-03) are set to 13 or 14, their function will be the same as the UP/DOWN keys.
- 01: Frequency command source is the analog input terminal AI1.
- 02: Frequency command source is the analog input terminal AI2.
- 03: Frequency command source is the RS485 serial communication.
- 04: Frequency command source depends on the setting of Pr. 04-20.

**02 - 01**  Source of Operation Command

Factory Setting: 00

- Settings
- 00: Controlled by the digital keypad
  - 01: Controlled by the external terminals, keypad STOP enabled.
  - 02: Controlled by the external terminals, keypad STOP disabled.
  - 03: Controlled by the RS-485 communication interface, keypad STOP enabled.
  - 04: Controlled by the RS-485 communication interface, keypad STOP disabled.

 This parameter sets the operation command source of the AC drive.**02 - 02** Stop Method

Factory Setting: 00

- Settings
- 00: Stop = ramp to stop, E.F. (External Fault) = coast to stop
  - 01: Stop = coast to stop, E.F. = coast to stop
  - 02: Stop = ramp to stop, E.F. = ramp to stop
  - 03: Stop = coast to stop, E.F. = ramp to stop

 Ramp: The AC drive decelerates the motor to minimum output frequency according to the deceleration time setting.

- Coast: The AC drive output instantly stops upon command and the motor free spins until it comes to a complete stop.
- External Fault may be enabled by the EF terminal or a Multi-Function terminal. Please refer to Pr.04-00 to 04-03.

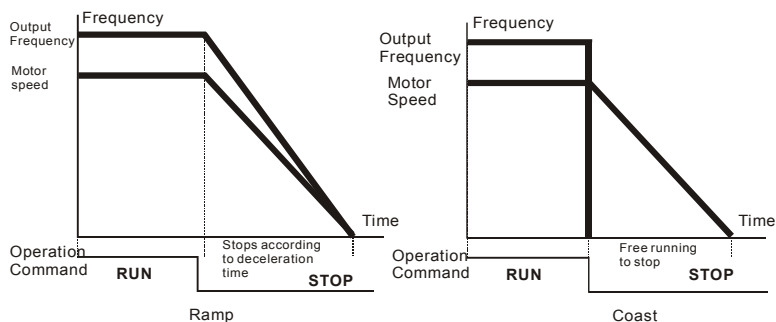

#### 02 - 03 PWM Carrier Frequency Selections

Settings	7.5~10HP: 4000~6000Hz	Factory Setting: 6000
	15~30HP: 3000~6000Hz	Factory Setting: 6000
	40~125HP: 2000~6000Hz	Factory Setting: 4000
	150~300HP: 2000~4000Hz	Factory Setting: 4000

- This parameter sets the carrier frequency of PWM output. The factory setting and setting range depend on the model type.
- When the temperature of the heat sink is greater than its limit, the AC drive will automatically lower the carrier frequency to avoid overheating the AC drive.
- The Carrier frequency of the PWM output has a significant influence on the electromagnetic noise, heat dissipation of the AC drive, and the acoustic noise to the motor as shown in the following chart.

Carrier Frequency	Acoustic Noise	Electromagnetic Noise	Leakage Current	Heat Dissipation
Signification	Minimal	Signification	Signification	Signification
↓	↓	↓	↓	↓
Minimal	Signification	Minimal	Minimal	Minimal

- When the carrier frequency is low, current ripple of the AC drive is large. This may result in a current display value greater than the actual value.

**02 - 04** Forward/Reverse Enabled

Factory Setting: 00

Settings      00: Forward/Reverse enabled  
                  01: Reverse disabled  
                  02: Forward disabled

 This parameter enables the direction of the AC drive.

**02 - 05** 2-wire/3-wire Operation Control Modes

Factory Setting: 00

Settings      00: 2-wire (#1), FWD / STOP, REV / STOP  
                  01: 2-wire (#2), RUN/STOP, FWD/REV  
                  02: 3-wire operation

 This parameter sets the operation mode when operating by external terminals.

 Please refer to 02-01.

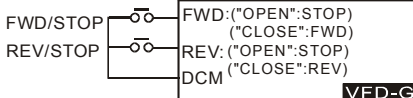
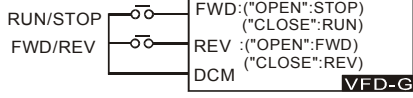
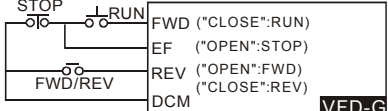
02-05	External Terminal
00 (2-wire #1) FWD / STOP REV / STOP	
01 (2-wire #2) REV / FWD RUN / STOP	
02 3-wire	

**02 - 06** Line Start Lockout

Factory Setting: 01





Settings      00: Disabled  
                  01: Enabled

 When enabled, the AC drive will not start when powered up with a run command applied. The AC drive must see the run command transition from stop to run after power up. When Line Start Lockout is disabled (also known as Auto-Start), the AC drive will start when powered-up with run commands applied.

**02 - 07** Reserved**02 - 08** Start-up Display Selection

Factory Setting: 00



Settings	Bit0~1: 00 = F LED 01 = H LED 10 = U LED (special display) 11 = Fwd / Rev
	Bit2: 0 = Fwd LED / 1 = Rev LED
	Bit3~5: 000 = 1st 7-step 001 = 2nd 7-step 010 = 3rd 7-step 011 = 4th 7-step 100 = 5th 7-step
	Bit6~7: Reserved

-  This parameter determines the display on keypad after each power up.
-  To program this parameter the user must first generate a Hex value with the information above. Then using the Hex to Decimal conversion to find the corresponding Decimal value and enter it into this parameter.
-  For example, a setting of 21 (decimal 21= hex 010101) will display the "H" and "REV" LEDs and the cursor will stay at the 3rd 7-step display upon power up.
-  When setting to U LED, please refer to 02-09.

**02 - 09** Special Display

Factory Setting: 00

Settings	00: A displays output current of AC drive 01: U displays DC-Bus voltage of AC drive 02: E displays RMS of output voltage 03: P displays feedback signal 04: PLC display auto procedure state
----------	--



-  This parameter chooses the display on the keypad immediately following the "U" user defined setting.
-  "MODE" key will scroll from "F", "H", "U", (Pr. 02-09), FWD, and back to "F".
-  Users may also use the "LEFT" key on the digital keypad to switch display content.

**02 - 10** ✓ User Defined Coefficient

Unit: 0.01

Settings 0.01~160.00



Factory Setting: 1.00

-  When this parameter is set, the "H" display value = actual output frequency of AC drive x 02-10.
-  If output frequency of AC drive is 90Hz, set 02-10 to 2.5. When H LED lights, the value on the display is 225.00.

**02 - 11** ✓ Flying Start

Factory Setting: 00

Settings 00: Disabled  
01: Enabled (DC braking disabled)

-  When the AC drive starts into a running motor (Flying Start), it may cause an over current on the drive and may damage the motor. Using speed search upon start-up will allow the drive to slowly find the motor speed, smoothly take control of the motor, and bring it to command speed.
-  If the Flying Start feature is enabled upon start-up, the DC braking 08-01 will be disabled.





**02 - 12** ✓ Flying Start Frequency

Factory Setting: 00

Settings 00: Begin search from Master Frequency Command  
01: Begin search from Maximum Frequency (Pr.01-00)**02 - 13** ✓ Master Frequency Memory Setting

Factory Setting: 01

Settings 00: Do not remember the last known frequency  
01: Remember the last known frequency

-  If this parameter is set to 00: The AC drive will not store the last known master frequency command, after power is removed.
-  If this parameter is set to 01: The AC drive will memorize the last known master frequency command after power off. Upon power up the last known frequency is displayed.
-  After a fault, the AC drive will always remember the last know master frequency command.
-  This feature is only enabled when Pr. 02-00 is set for 0 or 4.

**Group 3: Output Function Parameters****03 - 00** Multi-function Output terminal 1 (Relay)

Settings 00-21

Factory Setting: 01

Setting	Functions	Descriptions
00	Disabled	
01	Indication during operation	The corresponding output will be closed during operation (including DC braking time).
02	Master frequency attained	The corresponding output will be closed when output frequency reaches master frequency command.
03	Zero Speed (including shutdown)	The corresponding output will be closed when the AC drive has no output voltage signal.
04	Over-torque	The corresponding output relay will be closed when the AC drives output current exceeds the over-torque detection level 06-04.
05	External Fault	The corresponding output will be closed when the EF is enabled. (Pr. 04-00 to 04-03)
06	Low voltage detection	The corresponding output will be closed when the DC Bus voltage drops below our threshold. The keypad will display "Lu".
07	Operation Mode indication	The corresponding output will be closed when the AC drives "Operation Command" is controlled by the external terminals.
08	Fault Indication	The corresponding output will be closed when AC drive has experienced a fault.
09	Master Frequency Attained 1	The corresponding output will be closed when the AC drives output frequency exceeds (Pr.03-08) Master Frequency Attained 1.
10	Master Frequency Attained 2	The corresponding output will be closed when the AC drives output frequency exceeds (Pr.03-09) Master Frequency Attained 2.
11	Over Temperature indication	The corresponding output will be closed when the AC drive temperature exceeds its rating.
12	Drive Ready	The corresponding output will be closed the when the AC drive is ready and has no faults.
13	External Emergency Stop (EF1)	The corresponding output will be closed when multi-function input terminals (Pr.04-00 to 04-03) are set to emergency stop and then activated.
14	Software braking output	The corresponding output will be closed when the AC drives DC bus voltage exceeds (Pr.08-19) the braking level.
15	OL or OL1 overload warning	The corresponding output will be closed upon an overload (OL or OL1) fault.
16	Low current indication	The corresponding output will be closed when the AC drives output current is lower than the Low Current setting (Pr.06-08).



Setting	Functions	Descriptions
17	PID feedback error indication	The corresponding output will be closed when the PID feedback signal has an error.
18	Auto Running Command	The Output will be closed when PLC Program is running.
19	1-Step Running Completed	The Output will be closed for 0.5 sec when each multi-step speed is attained.
20	Auto Running Completed	The output will be closed for 0.5 sec when the PLC program cycle has completed
21	Auto Running Paused	The output will be closed when PLC operation is paused.

 Standard relay specifications = 10A/250VAC or 12A/24VDC.

 Relay delay time is 5~10 msec.

**03 - 01** Reserved

**03 - 02** Master Frequency Attained 1 Unit: 0.01

**03 - 03** Master Frequency Attained 2 Unit: 0.01

Settings 0.00~160.00 Hz

Factory Setting: 0.00

 An output relay may be programmed to activate when the output frequency exceeds the desired attained frequency setting of these two parameters.

 There is a  $\pm 2\text{Hz}$  window of operation. If the master frequency attained is 20Hz and the output frequency exceeds 20Hz, the corresponding output relay will be "closed". When the output frequency is less than 18Hz, the corresponding output relay will be "opened" as the following diagram shows.

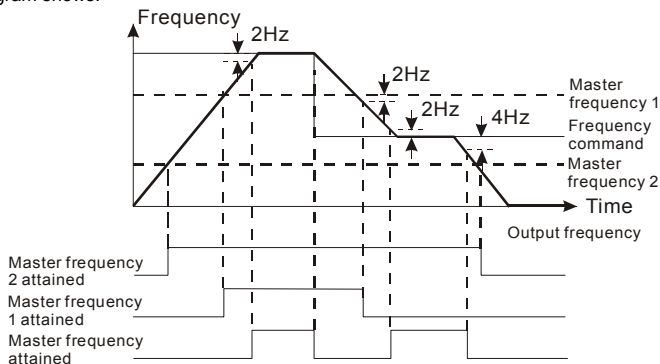

**03 - 04** DC Fan Control

Factory Setting: 00

- Settings
- 00: Fan runs on power up.
  - 01: Fan begins upon a RUN command. Fan stops 1 minute after a STOP command.
  - 02: Fan begins upon a RUN command. Fan stops after a STOP command
  - 03: Fan is controlled by temperature. Fan will be started at approximate 60°C.

 This parameter determines DC fan control method.

**03 - 05** Analog Output 1, (AFM1) 0~10Vdc

Factory Setting: 00

**03 - 06** Analog Output 2, (AFM2) 0/4~ 20mA

Factory Setting: 01

- Settings
- 00: Output frequency
  - 01: Output current
  - 02: Output voltage
  - 03: Frequency command
  - 04: Power factor loading

 These parameters select the content of the analog output signals AFM1 and AFM2.

 Setting 00: 0-10V = 0 - (Pr.01-00)

 Setting 01: 0-10V = 0 - (Double rated current)

 Setting 02: 0-10V = 0 - (Pr.01-02)

 Setting 03: 0-10V = 0 - Master Freq. command

 Setting 04: 0-10V = 0.0 - output power factor 1.0

 When using 0-20mA output, please refer to Pr. 3-14.

 Maximum impedance loading of analog output 2 (AFM2) can't be greater than 500 ohms.

**03 - 07**  Analog Output Gain 1**03 - 08**  Analog Output Gain 2

Settings 01~200%

Factory Setting: 100

 These parameters are to determine analog output gain.

 The analog output is limited to 10V and 20mA. The gain is designed to offer a normally small output signal to be enlarged for easier viewing on a meter.

Factory Setting: 01

Settings    00: 0~20mA  
              01: 4~20mA

---

 This parameter selects the output range of Analog Output 2 (AFM2).

**Group 4: Input Function Parameters**

<b>04 - 00</b>	Multi-function Input terminal 1	Factory Setting: 01
<b>04 - 01</b>	Multi-function Input terminal 2	Factory Setting: 02
<b>04 - 02</b>	Multi-function Input terminal 3	Factory Setting: 03
<b>04 - 03</b>	Multi-function Input terminal 4	Factory Setting: 04
	Settings 00~31	Factory Setting: 04





Setting	Functions	Descriptions
00	Disabled	All unused terminals should be set to 00, to assure they have no effect on drive operation.
01	Multi-Speed terminal 1	Allows selection of the 15 multi-step speeds. Please refer to 05-00 to 05-14 to program the 15 step speeds.
02	Multi-Speed terminal 2	
03	Multi-Speed terminal 3	
04	Multi-Speed terminal 4	
05	Reset (NO)	Clears (Reset) a fault and returns the AC drive to normal operation.
06	Reset (NC)	
07	Jog operation (JOG)	Enables the JOG command. Works identical to the JOG key on the digital keypad.
08	Accel/Decel disable	Stops the acceleration or deceleration of the AC drive. AC drive then maintains a constant speed.
09	1st and 2nd Accel/Decel selection	A corresponding terminal set to value 09 and closed selects Accel/Decel time 2. A corresponding terminal set to value 10 and closed selects Accel/Decel time 3. Accel/Decel time 4 is selected when both terminals are closed.
10	3rd and 4th Accel/Decel selection	
11	B.B. (NO) input	Enables the base block (pause) function. Please refer to Pr.08-08, for base block functions.
12	B.B. (NC) input	
13	Increase Frequency	Enables the external terminals to increase or decrease the Master Frequency command each time an input is received. Terminals are not active during a stop command.
14	Decrease Frequency	
15	Emergency stop (NO)	Generates an external fault (EF1). The function is identical to the external terminal (EF).
16	Emergency stop (NC)	
17	KEYPAD(open), EXT(close)	External selection of the Operation Command Source. (Keypad = terminal open) or (External terminals = terminal closed). This setting is valid when Pr.02-01 is set to 00. Otherwise, the Operation Command Source will follow the setting in Pr.02-01.

Setting	Functions	Descriptions
18	PID disabled	Disable PID feedback control and operate via Master Frequency Command source Pr.02-00.
19	Run PLC Program	Parameter value 32 programs Multi-Function Input Terminal to enable the AC drive internal PLC program. Parameter value 33 programs an input terminal to pause the PLC program. Note: Pr.05-00 to Pr.05-16 defines the PLC program.
20	Pause PLC Program	
21	1st Output Frequency Gain (Pr.04-30)	Output frequency multiplies a gain (Pr.04-30) · $H=F*(Pr.04-30)$
22	2nd Output Frequency Gain (Pr.04-31)	Output frequency multiplies a gain (Pr.04-31) · $H=F*(Pr.04-31)$
23	3rd Output Frequency Gain (Pr.04-32)	Output frequency multiplies a gain (Pr.04-32) · $H=F*(Pr.04-32)$

**04 - 04** Digital Input Terminal Response Time

Settings 01~20

Factory Setting: 01

-  This parameter selects the response time of digital input terminals MI1 to MI4, EF and FWD.
-  AC drive will scan the digital input terminals once every 2msec. During each scan the drive will check the status of each terminal (open or closed).
-  In noisy environments, it would be advantageous to verify the terminal status several times before executing a new command, nearly eliminating false signals.
-  Example: If Pr.04-04 is set to 4, the AC drive will confirm the terminal status  $(4+1 = 5)$  5 times before a change is made. This correlates to an 8~10msec time response from input command to execution.
-  It is not recommended to set this parameter to 00, since interference may cause improper operation of the AC drive.

**04 - 05** Minimum AI1 Analog Input

Unit: 1

Settings 0 ~ 100%

Factory Setting: 0

**04 - 06** Maximum AI1 Analog Input

Unit: 1

Settings 0 ~ 100%

Factory Setting: 100

**04 - 07** Minimum Output that corresponds to AI1

Unit: 0.01

Settings 0.00~100.00%

Factory Setting: 0.00

**04 - 08** Maximum Output that corresponds to AI1

Unit: 0.01

Settings 0.00~100.00%

Factory Setting: 100.00

<b>04 - 09</b>	Minimum AI2 Analog Input	Unit: 1
	Settings 0 ~ 100%	Factory Setting: 0
<b>04 - 10</b>	Maximum AI2 Analog Input	Unit: 1
	Settings 0 ~ 100%	Factory Setting: 100
<b>04 - 11</b>	Minimum Output that corresponds to AI2	Unit: 0.01
	Settings 0.0~100.0%	Factory Setting: 0.00
<b>04 - 12</b>	Maximum Output that corresponds to AI2	Unit: 0.01
	Settings 0.0~100.0%	Factory Setting: 100.00
<b>04 - 13</b>	↗ 1st AI1 Gain	Unit: 0.1
<b>04 - 14</b>	↗ 2nd AI1 Gain	Unit: 0.1
<b>04 - 15</b>	↗ 3rd AI1 Gain	Unit: 0.1
<b>04 - 16</b>	↗ 4th AI1 Gain	Unit: 0.1
<b>04 - 17</b>	↗ 5th AI1 Gain	Unit: 0.1
<b>04 - 18</b>	↗ 1st AI2 Gain	Unit: 0.1
<b>04 - 19</b>	↗ 2nd AI2 Gain	Unit: 0.1
<b>04 - 20</b>	↗ 3rd AI2 Gain	Unit: 0.1
<b>04 - 21</b>	↗ 4th AI2 Gain	Unit: 0.1
<b>04 - 22</b>	↗ 5th AI2 Gain	Unit: 0.1
	Settings 0.0~100.0%	Factory Setting: 100.0

 These parameters set analog input value and maximum output frequency (01-00, used in open-loop control) or the corresponding function of the detection reference value (10-01, used in PID closed-loop control). They divide output frequency into several sections according to Pr.04-26 to Pr.04-29. There is an independent gain and minimum output frequency in every section. We can reduce inferior products and improve working efficiency via parameter modification. For example, we set frequency via two groups analog input terminals. When the frequency we set is 0-15Hz and the gain is 50%, the minimum output frequency will be 5Hz; when the frequency we set is 15-35Hz and the gain is 80%, the minimum output frequency will be 15Hz; when the frequency we set is 35-50Hz and the gain is 150%, the minimum output frequency will be 35Hz as the following diagram shows.

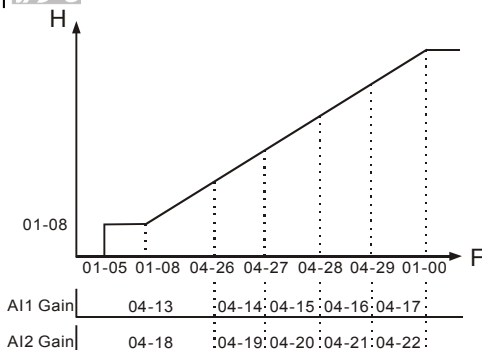



<b>04 - 23</b>	Analog Input Delay AI1	Unit: 0.01
----------------	------------------------	------------

<b>04 - 24</b>	Analog Input Delay AI2	Unit: 0.01
----------------	------------------------	------------

Settings	0.00 ~ 10.00 Sec
----------	------------------

Factory Setting: 0.50
-----------------------

 These parameters select the time constant for the analog input signal filter. A properly adjusted time constant may help filter noise on the analog input terminals.

 If the input delay is set too long, the system may experience oscillation. Be careful setting these parameters.

<b>04 - 25</b>	Summation of External Frequency Sources
----------------	---

Factory Setting: 00
---------------------

Settings	00: disabled
	01: $AI1*(AI1\ Gain)+AI2*(AI2\ Gain)$
	02: $AI1*(AI1\ Gain)-AI2*(AI2\ Gain)$
	03: $AI1*(AI1\ Gain)*AI2*(AI2\ Gain)$
	04: Reserved
	05: Communication master frequency + $AI1*(AI1\ Gain)$
	06: Communication master frequency + $AI2*(AI2\ Gain)$
	07: Max ( $AI1*(AI1\ Gain)$ , $AI2*(AI2\ Gain)$ )

 This parameter selects the terminals used for summation of the External Frequency Sources.

 Setting 07 is used to compare  $AI1*(AI1\ Gain)$  with  $AI2*(AI2\ Gain)$ . If  $AI1*(AI1\ Gain) > AI2*(AI2\ Gain)$ , it indicates that command source is from AI1, otherwise is from AI2.

<b>04 - 26</b>	↗ 1st Analog Input Frequency Gain	Unit: 0.01
<b>04 - 27</b>	↗ 2nd Analog Input Frequency Gain	Unit: 0.01
<b>04 - 28</b>	↗ 3rd Analog Input Frequency Gain	Unit: 0.01
<b>04 - 29</b>	↗ 4th Analog Input Frequency Gain	Unit: 0.01
Settings      0.00~160.00Hz		Factory Setting: 0.00

 These parameters divide output frequency into several sections. (Refer to Pr.04-22).

<b>04 - 30</b>	↗ 1st Output Frequency Gain	Unit: 0.1
<b>04 - 31</b>	↗ 2nd Output Frequency Gain	Unit: 0.1
<b>04 - 32</b>	↗ 3rd Output Frequency Gain	Unit: 0.1
Settings      0.0~200.0%		Factory Setting: 100.0

 These parameters set output frequency gain. We can select the functions of 21st to 23rd via multi-function terminal. When the multi-function terminal is active, output frequency multiplies a gain, i.e. output frequency  $H = F * (\text{Pr.04-30}/04\text{-}31/04\text{-}32)$ .



**Group 5: Multi-step Speed Parameters**

<b>05 - 00</b>	↗ 1st Step Speed Frequency	Unit: 0.01
<b>05 - 01</b>	↗ 2nd Step Speed Frequency	Unit: 0.01
<b>05 - 02</b>	↗ 3rd Step Speed Frequency	Unit: 0.01
<b>05 - 03</b>	↗ 4th Step Speed Frequency	Unit: 0.01
<b>05 - 04</b>	↗ 5th Step Speed Frequency	Unit: 0.01
<b>05 - 05</b>	↗ 6th Step Speed Frequency	Unit: 0.01
<b>05 - 06</b>	↗ 7th Step Speed Frequency	Unit: 0.01
<b>05 - 07</b>	↗ 8th Step Speed Frequency	Unit: 0.01
<b>05 - 08</b>	↗ 9th Step Speed Frequency	Unit: 0.01
<b>05 - 09</b>	↗ 10th Step Speed Frequency	Unit: 0.01
<b>05 - 10</b>	↗ 11th Step Speed Frequency	Unit: 0.01
<b>05 - 11</b>	↗ 12th Step Speed Frequency	Unit: 0.01
<b>05 - 12</b>	↗ 13th Step Speed Frequency	Unit: 0.01
<b>05 - 13</b>	↗ 14th Step Speed Frequency	Unit: 0.01
<b>05 - 14</b>	↗ 15th Step Speed Frequency	Unit: 0.01
Settings      0.00~160.00 Hz		Factory Setting: 0.00

 The Multi-Function Input Terminals (refer to Pr.04-00 to 04-03) are used to select one of the AC drive Multi-Step speeds. The speeds (frequencies) are determined by Pr.05-00 to 05-14 shown above.

**05 - 15** PLC Mode

Factory Setting: 00

Settings	00	Disable PLC operation
	01	Execute one program cycle only
	02	Continuously execute program cycles
	03	Execute one program cycle only and step by step
	04	Continuously execute program cycles step by step

 This parameter selects the mode of PLC operation for the AC drive. The AC drive will change speeds and directions according to the user's desired programming.

**Example 1 (Pr.05-15 = 1): Execute one cycle of the PLC program. Its relative parameter settings are:**

- Pr.05-00 to 05-14: 1st to 15th step speeds (sets the frequency of each step speed)
- Pr.04-00 to 04-03: Multi-Function Input Terminals (set one multi-function terminal as 32 - PLC auto-operation).
- Pr.03-00: Multi-Function Output Terminals (set a Multi-Function Terminal as 34-PLC running indication, 35-PLC step completed or 36-PLC program completed).
- Pr.05-16: Direction of the 1st to 15th step speeds.
- Pr.05-17 to 05-31: Operation time setting for each corresponding step speed.

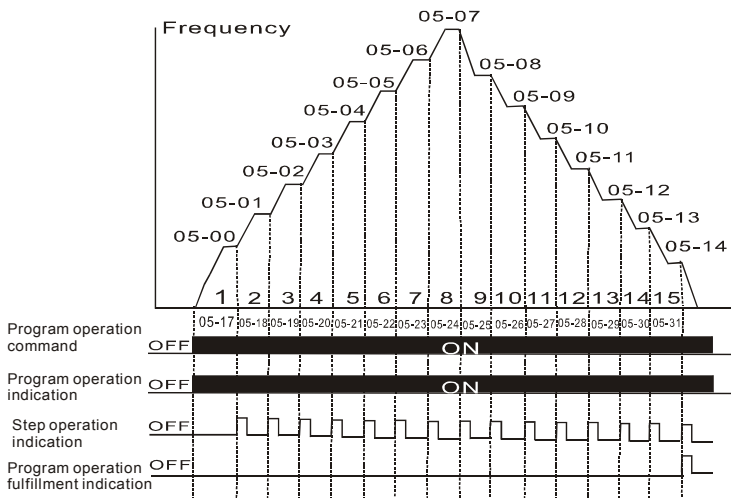

Note: The above diagram shows one complete PLC operation cycle. To restart this cycle, turn the multi-function input terminal that designed as PLC program off and on again.

**Example 2 (Pr.05-15 = 2): Continuously executes program cycles:**

The diagram above shows the PLC program stepping through each speed. Set Pr.05-15 to 2 for continuous program execution. To stop the PLC program, one must either pause the function or turn it off. (Refer to Pr.04-00 to 04-03 values 32 and 33).

**Example 3 (Pr.05-15 = 3) Execute one cycle step by step:**

The example below shows how the PLC can perform one cycle at a time, within a complete cycle. Each step will use the accel/decel times in Pr.01-09 to Pr.01-16. It should be noticed that the time each step spends at its intended frequency is diminished, due to the time spent during accel/decel.

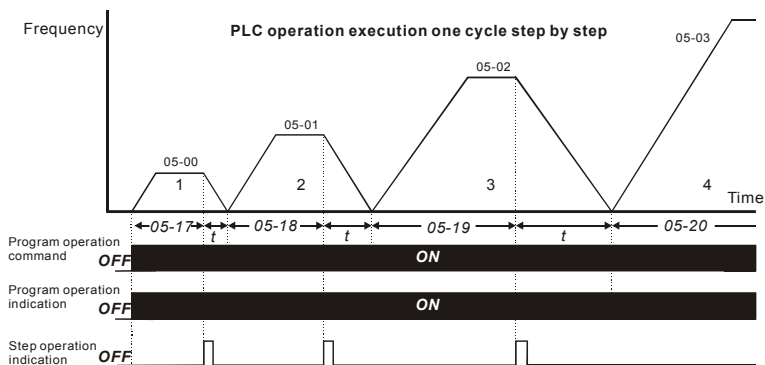
**05 - 16** PLC Forward/Reverse Motion

Settings 00 to 32767 (0:Forward, 1:Reverse)

Factory Setting: 00

This parameter controls the direction of motion for the Multi-Step Speeds Pr.05-00 to Pr.05-14 during PLC mode. All other direction commands are invalid during the PLC mode.

Note: The equivalent 15-bit number is used to program the forward/reverse motion for each of the 15 speed steps. The binary notation for the 15-bit number must be translated into decimal notation and then entered.

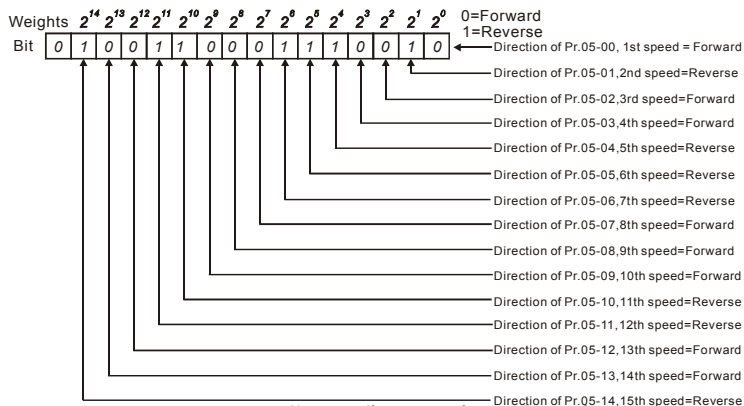
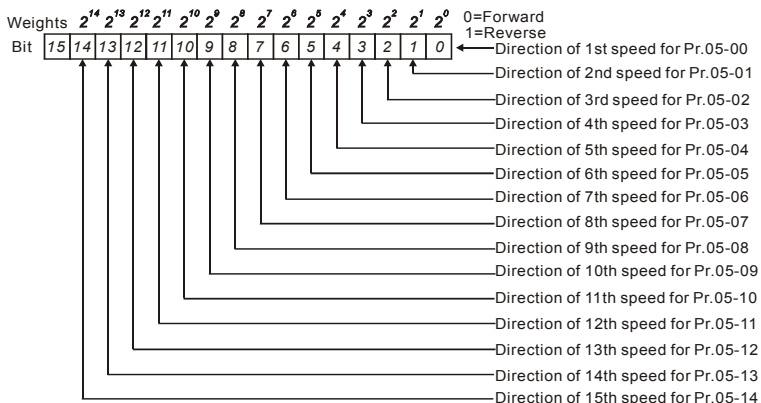

$$\begin{aligned} \text{The setting value} &= \text{bit}14 \times 2^{14} + \text{bit}13 \times 2^{13} + \dots + \text{bit}2 \times 2^2 + \text{bit}1 \times 2^1 + \text{bit}0 \times 2^0 \\ &= 1 \times 2^{14} + 1 \times 2^{11} + 1 \times 2^{10} + 1 \times 2^9 + 1 \times 2^8 + 1 \times 2^7 + 1 \times 2^6 + 1 \times 2^5 + 1 \times 2^4 + 1 \times 2^3 + 1 \times 2^2 + 1 \times 2^1 + 1 \times 2^0 \\ &= 16384 + 2048 + 1024 + 64 + 32 + 16 + 2 \\ &= 19570 \\ \text{Setting 05-16} &= 19570 \end{aligned}$$

NOTE:

$2^{14} = 16384$	$2^{13} = 8192$	$2^{12} = 4096$	$2^{11} = 2048$	$2^{10} = 1024$
$2^9 = 512$	$2^8 = 256$	$2^7 = 128$	$2^6 = 64$	$2^5 = 32$
$2^4 = 16$	$2^3 = 8$	$2^2 = 4$	$2^1 = 2$	$2^0 = 1$

<b>05 - 17</b>	Time Duration of 1st Step Speed	Unit: 1 /0.1sec
<b>05 - 18</b>	Time Duration of 2nd Step Speed	Unit: 1 /0.1sec
<b>05 - 19</b>	Time Duration of 3rd Step Speed	Unit: 1 /0.1sec
<b>05 - 10</b>	Time Duration of 4th Step Speed	Unit: 1 /0.1sec
<b>05 - 21</b>	Time Duration of 5th Step Speed	Unit: 1 /0.1sec
<b>05 - 22</b>	Time Duration of 6th Step Speed	Unit: 1 /0.1sec
<b>05 - 23</b>	Time Duration of 7th Step Speed	Unit: 1 /0.1sec
<b>05 - 24</b>	Time Duration of 8th Step Speed	Unit: 1 /0.1sec
<b>05 - 25</b>	Time Duration of 9th Step Speed	Unit: 1 /0.1sec
<b>05 - 26</b>	Time Duration of 10th Step Speed	Unit: 1 /0.1sec
<b>05 - 27</b>	Time Duration of 11th Step Speed	Unit: 1 /0.1sec
<b>05 - 28</b>	Time Duration of 12th Step Speed	Unit: 1 /0.1sec
<b>05 - 29</b>	Time Duration of 13th Step Speed	Unit: 1 /0.1sec
<b>05 - 30</b>	Time Duration of 14th Step Speed	Unit: 1 /0.1sec
<b>05 - 31</b>	Time Duration of 15th Step Speed	Unit: 1 /0.1sec
Settings 0.0~65500 Sec / 0.0~6550.0 Sec		Factory Setting: 0.0

 Pr.05-17 to Pr.05-31 correspond to operation time of each step speed defined by Pr.05-00 to Pr.05-14. The maximum setting 65500 seconds will be displayed as t6550. If it is displayed t6550. that means 6550 seconds.

Note: If a parameter is set to "00" (0 sec), the corresponding step will be skipped. This is commonly used to reduce the number of program steps.

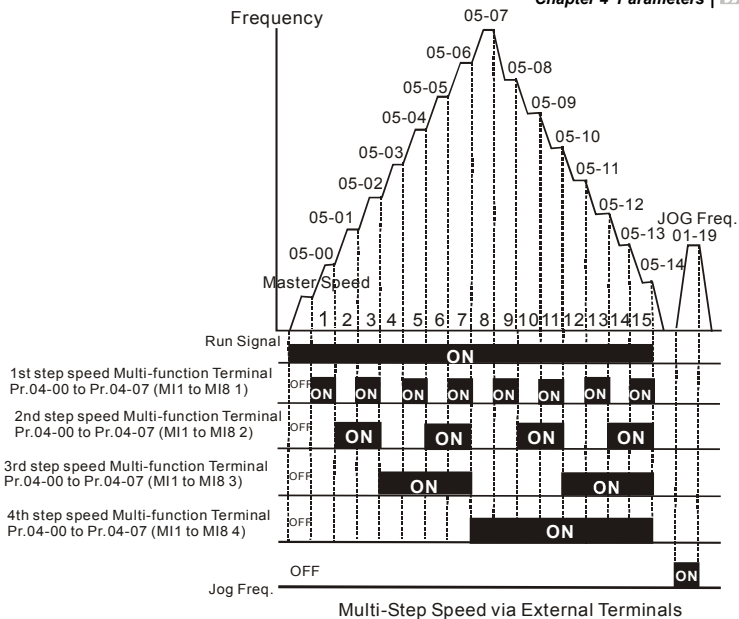

## 05 - 32 Time Unit Settings

Factory Setting: 00

Settings	00	1 Sec
	01	0.1 Sec





This parameter determines the time unit for Pr.05-17~Pr.05-31.

**Group 6: Protection Function Parameters****06 - 00** Over-voltage Stall Prevention

Factory Setting: 780.0

Settings      660.0V~820.0VDC  
 00: Disabled

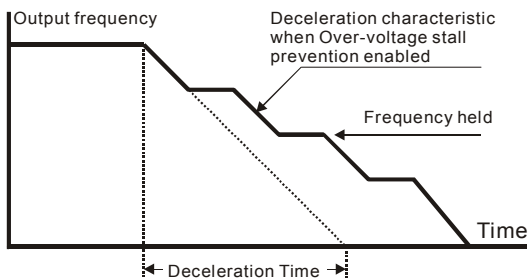

-  This parameter selects the voltage level for the Over-Voltage Stall Prevention function.
-  During decelerations, the DC bus voltage may exceed its maximum allowable value due to motor regeneration. When this function is enabled, the AC drive will stop decelerating and maintain a constant output frequency. The AC drive will only resume deceleration when the voltage drops below the preset value.
-  With moderate inertial loads, the over-voltage stall prevention will not occur and the deceleration time should be equal to Pr.1-10. With high inertial loads, the AC drive will automatically extend the deceleration time due to the step function shown below. If the deceleration time is critical for the application, then dynamic braking resistors should be used.

**06 - 01** Over-current Stall Prevention during Acceleration

Unit: 1

Settings      20~250%

Factory Setting: 150%

-  This parameter selects the percentage of allowable over-current during acceleration before the stall prevention is enabled.
-  During acceleration, the AC drive output current may increase abruptly and exceed the value specified by Pr.06-01 due to rapid acceleration or excessive load on the motor. When this function is enabled, the AC drive will stop accelerating and maintain a constant output frequency. The AC drive will only resume acceleration when the current drops below the value set in Pr.06-01 (please see the graph below).

- When the over-current stall prevention is activated, the acceleration time of the AC drive will be longer than the time set in Pr. 01-09.

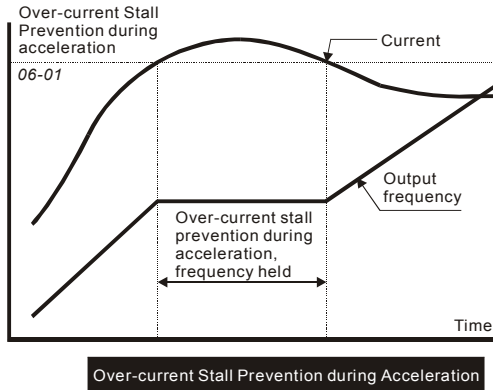
**06 - 02** Over-current Stall Prevention during operation

Unit: 1

Settings 20~250%

Factory Setting: 150%

- This parameter selects the percentage of allowable over-current during operation before the stall prevention function is enabled.
- If the output current exceeds the value specified in Pr.06-02 when the drive is operating at steady state speed, the drive will decrease its output frequency to prevent the drive from faulting with an OC. Once the current falls below the value specified in Pr.06-02, the drive will then accelerate to catch up with the command frequency.

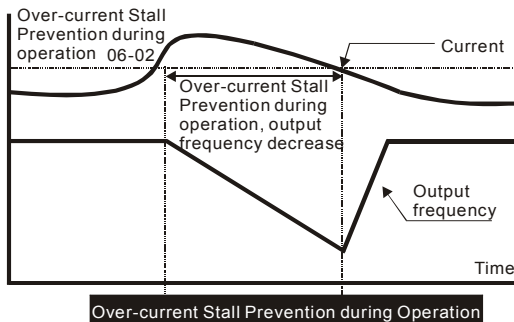



**06 - 03** Over-torque Detection Selection

Factory Setting: 00

Settings	00: Over-torque detection disabled.
	01: Over-torque detection enabled during constant speed operation (OL2), and operation continues.
	02: Over-torque detection enabled during constant speed operation (OL2), and operation halted.
	03: Over-torque detection enabled during operation (OL2), and operation continues.
	04: Over-torque detection enabled during constant speed operation (OL2), and operation halted.

 This parameter selects the Over-torque Detection operation.

 If this parameter is set to 01 or 02, over-torque detection will not occur during acceleration.

**06 - 04** Over-torque Detection Level

Unit: 1

Settings	30~150%	Factory Setting: 110
----------	---------	----------------------

 This parameter sets the Over-torque Detection level based on the AC drive rated current.

**06 - 05** Over-torque Detection Time

Unit: 0.1

Settings	0.1~60.0 Sec	Factory Setting: 0.1
----------	--------------	----------------------

 This parameter selects the allowable time of Over-torque Detection before the AC drive faults with an OL2.

 When the output current exceeds Pr.06-04 for the time set in Pr06-05, AC drive will fault and display "OL2" on the keypad.

**06 - 06** Electronic Thermal Relay Selection

Factory Setting: 02

Settings	00: Operation disabled.
	01: Operation with a standard motor (shaft mounted fan cooled).
	02: Operation with a vector motor (non-fan cooled or self powered fan)

 This parameter provides electronic thermal protection for the motor. When the output current exceeds Pr.07-02 for the time set in Pr.06-07, the drive will fault with an OL1.

**06 - 07** Electronic Thermal Characteristic

Unit: 1

Settings	30~600 Sec	Factory Setting: 60
----------	------------	---------------------

 This parameter selects the time required for the electronic thermal protection function to activate.

When Pr.6-06 is set for 1 or 2 and the output current exceeds Pr.7-02 for the time set in Pr.6-07, the drive will fault with an OL1.

The common electronic thermal reaction time (150% output current for 1 minute) is shown in the chart below. The actual reaction time will vary depending on output current.

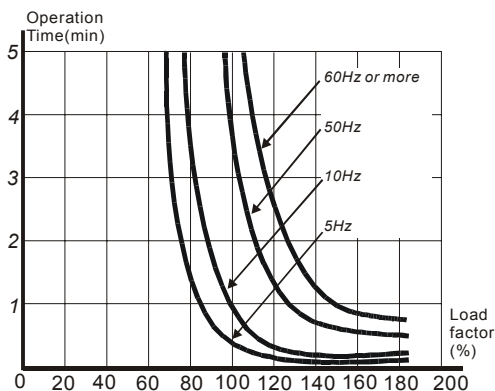

<b>06 - 08</b>	Low Current Detection Level	Unit: 1
Settings	00~100% (00 disabled)	Factory Setting: 00

<b>06 - 09</b>	Low Current Detection Time	Unit: 0.1
Settings	0.1~ 3600.0 Sec	Factory Setting: 10.0

<b>06 - 10</b>	Low Current Detection Treatment	Factory Setting: 01
Settings	00: Warn and Ramp to stop 01: Warn and Coast to stop 02: Warn and keep operating	

These parameters set the low current detection mode, time, and operation.

<b>06 - 11</b>	Present Fault Record
<b>06 - 12</b>	2nd Most Recent Fault Record
<b>06 - 13</b>	3rd Most Recent Fault Record
<b>06 - 14</b>	4th Recent Fault Record
	Factory Setting: 00

Settings	00	No fault occurred
	01	Over-current (oc)
	02	Over-voltage (ov)
	03	Overheat (oH)
	04	Overload (oL)
	05	Overload1 (oL1)
	06	External fault (EF)
	07	IGBT protection (occ)
	08	CPU failure (CF3)
	09	Hardware protection failure (HPF)
	10	Over-current during acceleration (Oca)
	11	Current exceeds 2 times rated current during decel. (ocd)
	12	Current exceeds 2 times rated current during steady state operation (ocn)
	13	Ground fault (GFF)
	14	Low voltage (Lv)
	15	CPU READ failure (CF1)
	16	CPU WRITE failure (CF2)
	17	Base Block (bb)
	18	Motor over load (oL2)
	19	Reserved
	20	Software/password protection (codE)
	21	Emergency stop (EF1)
	22	Phase-Loss (PHL)
	23	Low-current (Lc)
	24	Feedback Loss (FbL)
	25	Reserved
	26	Fan Power Fault (FANP)
	27	Fan 1 Fault (FF1)
	28	Fan 2 Fault (FF2)
	29	Fan 3 Fault (FF3)
	30	Fan 1, 2, 3 Fault (FF123)
	31	Fan 1, 2 Fault (FF12)
	32	Fan 1, 3 Fault (FF13)
	33	Fan 2, 3 Fault (FF23)
	34	Gate Drive Low Voltage Protect (Fv)
	35~40	Reserved
	41	GFF hardware error (HPF1)

42	CC,OC hardware error (HPF2)
43	OC hardware error (HPF3)
44	OV hardware error (HPF4)
45	U-phase error (CF3.3)
46	V-phase error (CF3.4)
47	W-phase error (CF3.5)
48	OV or LV (CF3.6)
49	Isum error (CF3.7)
50	Temperature sensor error (CF3.8)

---

**06 - 15** Parameter Reset

Factory Setting: 00

Settings	00~65535
	09: Reset parameters (50Hz, 380)
	10: Reset parameters (60Hz, 440)

---

 This parameter resets all parameters to the factory setting.

**06 - 16** Parameter Protection Password Input

Settings	00~65535	Factory Setting: 00
----------	----------	---------------------

---

 This parameter allows the user to enter their password to unlock the Parameter Protection feature. The password entered must match the value entered into Pr.6-17. After three invalid password attempts, the drive will no longer allow any operation. The drive must then be powered off and back on again.

 After successfully entering the password, the user may change parameters as they wish. Once the drive is powered off, the drive has locked the parameters again. To clear the password, the user must enter the correct password in Pr.6-16 and then set Pr.6-17 to 00.

**06 - 17** Parameter Protection Password Setting

Factory Setting: 00

Settings	00~65535
	00: No password protection

---

 This parameter allows the user to set a password for parameter protection. After entering a password, Pr.6-17 will display 1.

 Be sure to keep the password in a safe place. If the password is lost, please return the drive to DELTA.

**Group 7: AC Drive and Motor Parameters****07 - 00** Identity Code of AC Drive

Settings      Display by model type

Factory Setting: ##

 This parameter displays the AC drive model code.

 This parameter is read-only.

**07 - 01** Rated Current of AC Drive

Settings      Display by model type

Factory Setting: ##

 This parameter displays rated output current of the AC drive. The following chart may be used to look up the identity code, current, and hp of your drive.

kW	5.5	7.5	11	15	18.5	22	30	37	45	55	75	90	110	132	160	185	220
HP	7.5	10	15	20	25	30	40	50	60	75	100	125	150	175	215	250	300
Pr.07-00	13	15	17	19	21	23	25	27	29	31	33	35	37	39	41	43	45
Rated Current (A)	13	18	24	32	38	45	60	73	91	110	150	180	220	260	310	370	460
Max. Carried Freq.	6kHz		6kHz				6kHz						4kHz				
Min. Carried Freq.	4kHz		3kHz				2kHz						2kHz				
Factory Setting	6kHz		6kHz				4kHz						4kHz				

 This parameter is read-only.

**07 - 02** Full-load Current of Motor

Unit: 1

Settings      30~120%

Factory Setting: 100%

 This parameter selects the full load current of the motor.

 Pr7-02 = (full load motor current / drive rated current)

 Example: If the rated current of AC drive is 150A, full-load current of motor is 120A, then Pr.7-02 should be set to 80%.

 This parameter is used with slip compensation Pr.7-04 to Pr.7-05 and electronic thermal relay Pr.6-06 to Pr.6-07. An incorrect setting will cause these functions to not work incorrectly and may damage the motor and drive.



 The full-load current of the motor must be equal to or less than (but not less than 50%) the rated current of the AC drive.

**07 - 03** **↗** No-load Current of Motor

Unit: 1

Settings 1~99%

Factory Setting: 30%







-  This parameter sets the no-load current of the motor.  
Pr.7-03 = (no load current / drive rated current)  
Example: If the rated current of the AC drive is 150A and no-load current of the motor is 40A, then Pr.7-03 should be set to 27%.
-  This parameter is used with slip compensation Pr.7-04 and Pr.7-05. An incorrect setting will cause the function to work incorrectly and may damage the motor and drive.
-  If the no-load current of the motor is unavailable, it may be found by running the motor with no load and reading the current on the keypad display.

**07 - 04** **↗** Auto Slip Compensation Gain

Unit: 0.1

Settings 0.0~3.0

Factory Setting: 0.0

-  This parameter is set to auto slip compensation gain.
-  Rotor speed of the motor (output frequency of AC drive) can't synchronize due to induction motor characteristic. The difference between synchronization speed and rotor speed is called slip frequency. Slip frequency is in direct proportion with output torque and output current. Therefore, slip compensation could make rotor speed and master frequency command the same according output current (I<sub>o</sub>).
-  The equation of slip compensation is  $(07-05) \times (07-04) \times (I_o - (07-03)) / ((07-02) - (07-03))$ . If rated current of AC drive is 150A, full-load current of the motor is 120A, no-load current is 40A, rated slip frequency is 5Hz and output current of AC drive is 100A. At this time, slip compensation is  $(07-04) \times 5 \times (100 - 40) / (120 - 40) = 3.75 \times (07-04)$ . If 07-04 is set to 1.0 and the compensation is 3.75. If master frequency command is set to 50Hz and output frequency is 53.75.
-  Output frequency after compensation is limited by 01-07 upper bound frequency. When using slip compensation, 01-07 should be set to the suitable value.
-  When PID feedback control, slip compensation function will be disabled.
-  Unsuitable setting value may cause over compensation.

<b>07 - 05</b>	Rated Slip Frequency of Motor	Unit: 0.01
Settings	0.00~20.00Hz	Factory Setting: 0.00

 This parameter is to set rated slip of loaded motor. Users need to input rated rotation speed according to nameplate of loaded motor. If rated frequency of motor is 60Hz, number of motor poles is 4 and rated rotation speed of motor is 1650rpm. The rated slip frequency of motor is  $60\text{Hz} - (1650\text{rpm} \times 4 / 120) = 5\text{Hz}$ .

 This parameter has relation with 07-04 slip compensation. To have the best slip compensation, this parameter must be set correctly. Incorrect setting may cause above functions disable and even damage the motor and AC drive.

<b>07 - 06</b>	✓ Auto Torque Compensation Gain	Unit: 0.1
Settings	0.0~10.0	Factory Setting: 0.0

 This parameter is to set auto torque compensation gain.

 When motor loading is high, a part of output frequency of AC drive will be absorbed by impedance of stator winding to make voltage of exciting inductance of motor is not enough. Therefore, the short of gap magnet field will make a high output current but low output torque. Auto torque compensation gain could adjust output voltage automatically according to loading to maintain in a fixed gap magnet of the motor to get the best running situation.

 If the setting of compensation gain is too great, over-exciting magnet will cause the following situation: output current of AC drive is too great, motor is over-heating or protection function occurs.

<b>07 - 07</b>	✓ Torque Compensation Gain by Manual Operation	Unit: 1.0
Settings	0.0~10.0	Factory Setting: 0.0

 This parameter determines torque compensation gain by manual operation.

 Torque compensation gain by manual operation won't refer to the loading situation and adds compensation voltage on the setting V/f curve. Basically, it just changes V/f curve. It could be reached by adjusting V/f curve.

<b>07 - 08</b>	Calculate Total Running Time of the Motor (Min)	Unit: 1
Settings	00 to 1439 Min	Factory Setting: 00

<b>07 - 09</b>	Calculate Total Running Time of the Motor (Day)	Unit: 1
Settings	00 to 65535 Day	Factory Setting: 00

 This parameter could display running time of the motor.

---

**07 - 10** Electric Bill for One Time

---

Factory Setting: Read Only

---



---

**07 - 11** Accumulated Electric Bill (per currency unit)

---

Factory Setting: Read Only

---



---

**07 - 12** Accumulated Electric Bill (per 10<sup>4</sup> currency unit)

---

Factory Setting: Read Only

---



---

**07 - 13** Electric Rate (per currency unit)

---

Unit: 1

Settings 0.01 to 655.35

---

Factory Setting: 0.6

---

 You can get electric bill from Pr. 07-10 to Pr. 07-12 after inputting local electric rate into Pr. 07-13.





**Group 8: Special Parameters**

<b>08 - 00</b>	<b>DC Braking Current Level</b>	Unit: 1
Settings	00~100%	Factory Setting: 00

 This parameter determines the level of DC braking current output.

<b>08 - 01</b>	<b>DC Braking Time during Start-up</b>	Unit: 0.1
Settings	0.0~60.0 Sec	Factory Setting: 0.0

 This parameter determines the duration of time that the DC braking current will be applied to the motor during the AC drive start-up.

 The motor may rotate by external force or inertia itself before operating. It may damage the motor or start the AC drive protection function by an over current if the AC drive added at this time. This parameter enable the AC drive to output a direct current before running the motor that will produce a torque to forced motor stop and get a steady start-up characteristic.

<b>08 - 02</b>	<b>DC Braking Time during Stopping</b>	Unit: 0.01
Settings	0.00~60.00 Hz	Factory Setting: 0.0

 This parameter determines the duration of time that the DC braking current will be applied to the motor during stopping.

 Motor may be in rotation status after AC drive stops output and can't in stop status accuracy when motor is running with external force or itself inertia. After AC drive stops output, this parameter could output a DC current to produce torque force motor to stop and make sure the motor has stopped accuracy.

<b>08 - 03</b>	<b>Start-point for DC Braking</b>	Unit: 0.01
Settings	0.00~160.00 Hz	Factory Setting: 0.00

 This parameter determines the frequency when DC braking will begin during deceleration.



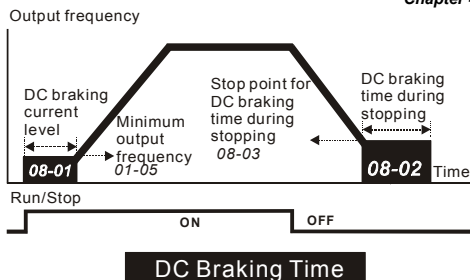

 If this parameter is set greater than 01-05 minimum frequency setting, it won't decelerate to 01-05 and enter DC braking status when AC drive brakes. Suitable DC braking start-up frequency setting will get better braking characteristic.



#### 08 - 04 Momentary Power Loss Operation Selection

Factory Setting: 00



Settings	00: Disabled
	01: Trace from top downward
	02: Trace from bottom upward

-  This parameter determines the start-up mode after momentary power loss operation.
-  The power system connects to AC drive may occurred momentary power loss by any probably reason. This function can make AC drive output voltage continuously after power loss and AC drive won't stop by power loss.
-  If this parameter is set to 01, AC drive will trace from the last frequency before power loss downward. After output frequency of AC drive and running speed of the motor is synchronization, it will accelerate to master frequency command. It is recommended to use this setting if the motor loading has the characteristics of high inertial and low resistance.
-  If this parameter is set to 02, AC drive will trace from the Min. frequency upward. After output frequency of AC drive and running speed of the motor is synchronization, it will accelerate to master frequency command. It is recommended to use this setting if the motor loading has the characteristics of low inertial and high resistance.

#### 08 - 05 Maximum Allowable Power Loss Time

Unit: 0.1

Settings	0.1~5.0 Sec	Factory Setting: 2.0
----------	-------------	----------------------





-  This parameter determines the maximum allowable power loss time. If the power loss time is less than the time defined by this parameter, the AC drive will execute 08-04 momentary power loss operation.
-  The allowable power loss time is beginning to count time after AC drive displays Lu. Therefore, actual allowable power loss time will change with loading.

-  The allowable power loss time must in the condition that AC drive auxiliary power is working normally. If auxiliary power is turned off in the allowable power loss time, the actual allowable power loss time will be shorter than the parameter setting.

<b>08 - 06</b>	Speed Search Time	Unit: 0.1
Settings	0.1~5.0 Sec	Factory Setting: 0.5

-  This parameter determines the delay time from fault (power loss, OV, OC or BB) recovery to start to execute the function of speed search time.

<b>08 - 07</b>	Maximum Speed Search Current	Unit: 1
Settings	30~150%	Factory Setting: 110

-  This parameter determines maximum current of speed search.
-  Maximum speed search current will have influence with synchronization attained time. The greater this parameter is set, the faster it will be synchronization. But if the parameter setting value is too great, it may occur over-loaded protection.
-  If 08-04 is set to 01: when speed search is from top downward, output frequency is searched from master frequency command downward. Now output voltage and output current will be added from zero. When output current is equal to 08-07 setting value, AC drive output current will retain in a fixed value and output frequency will keep on searching from top downward. When output frequency and output voltage is overlapped with V/f setting frequency, AC drive will judge that is synchronization attained and accelerates from V/f curve to master frequency command.
-  If 08-04 is set to 02: AC drive will accelerate according to V/f curve and won't do any special treatment.

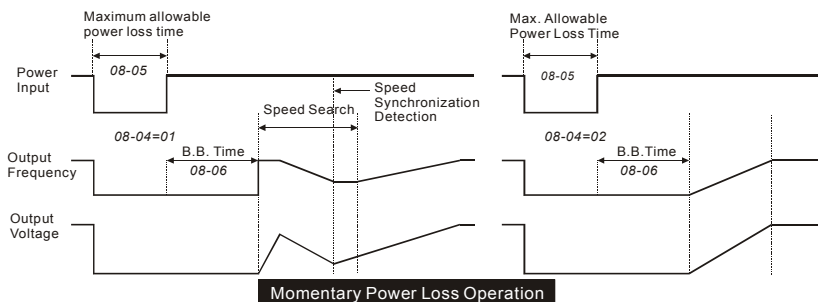

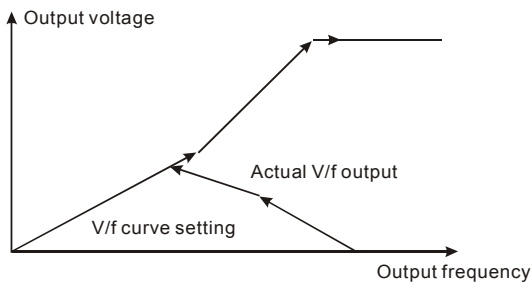
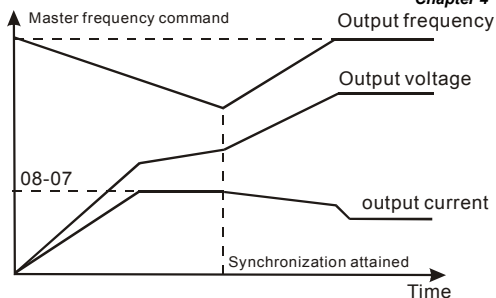

#### 08 - 08 BB Speed Search Method

Factory Setting: 00

Settings      00: Trace from top downward  
                  01: Trace from bottom upward

- This parameter determines BB speed search method when multi-function input terminal 04-00 to 04-03 is set to BB External interrupt (11 or 12) and activates.
- BB speed search method is the same with restart speed search after momentary loss power.

#### 08 - 09 Auto Restart Times After Fault

Settings      00 ~10

Factory Setting: 00

- This parameter determines the times of auto restart after fault.
- When AC drive occurs fault (OV, OC or OCC) and fault disappeared automatically, this parameter allows AC drive reset and runs with the parameter that is set before fault occurred.
- If fault occurred times exceed 08-09 setting, AC drive will reject to restart and need to reset by users to keep on running.

<b>08 - 10</b>	Auto Restart Time after Fault	Unit: 1
	Settings      00 to 60000 sec	Factory Setting: 600

-  This parameter determines auto restart time after fault. After fault occurs and restart, there is no fault occurs during 08-10 setting time, AC drive will reset fault occurred record to zero.

<b>08 - 11</b>	Operation Frequency Inhibition 1 UP	Unit: 0.01
<b>08 - 12</b>	Operation Frequency Inhibition 1 DOWN	Unit: 0.01
<b>08 - 13</b>	Operation Frequency Inhibition 2 UP	Unit: 0.01
<b>08 - 14</b>	Operation Frequency Inhibition 2 DOWN	Unit: 0.01
<b>08 - 15</b>	Operation Frequency Inhibition 3 UP	Unit: 0.01
<b>08 - 16</b>	Operation Frequency Inhibition 3 DOWN	Unit: 0.01
	Settings      0.00~160.00 Hz	Factory Setting: 0.00

-  These parameters determine the inhibition operation frequency range. This function will let AC drive not run continuous in the resonance frequency of the motor or loading system, or inhibition operation frequency.

-  The settings of these parameters should follow as 08-11 ≥ 08-12 ≥ 08-13 ≥ 08-14 ≥ 08-15 ≥ 08-16.

-  Master frequency command can be set in inhibition operation frequency range. Now the output frequency will be limited in the lower bound of inhibition operation frequency.

-  When AC drive accelerates or decelerates, output frequency will pass through inhibition operation frequency range.

<b>08 - 17</b>	Automatic Energy-saving	Factory Setting: 00
	Settings      00: Energy-saving operation disabled 01: Energy-saving operation enabled	

-  This parameter determines automatic energy-saving function.

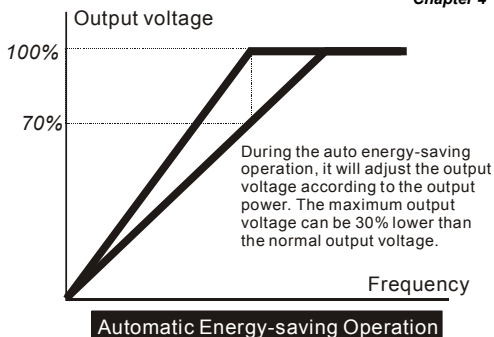

### 08 - 18 Automatic Voltage Regulation (AVR)

Factory Setting: 00

Settings	00: AVR function enabled
	01: AVR function disabled
	02: AVR function disabled for deceleration

- This parameter determines the function of Automatic Voltage Regulation is enabled or disabled.
- This parameter is set to 01: when AVR function is disabled, AC drive will calculate input voltage by DC Bus value (620VDC). Output voltage will vary by DC Bus varying and may cause output current insufficiently, over current or oscillation.
- This parameter is set to 00: when AVR function is enabled, AC drive will calculate output voltage by actual voltage value of DC Bus. Output voltage won't vary by DC Bus varying.
- This parameter is set to 02: AC drive will disable AVR function during decelerate to stop. It can speed up braking in some degree.

### 08 - 19 Software Setting of the Braking Level (the action level of the braking resistor)

Unit: 0.1

Settings	740.0V~820.0VDC	Factory Setting: 760.0
	00: Disabled	

- This parameter determines software setting of the braking level.
- The model VFD055~150F43A has braking chip, user could select suitable braking resistor to have the best deceleration characteristics.
- The action level of the braking resistor could be set by this parameter.

Settings 00~1000

Factory Setting: 00

-  This parameter will minimize vibration at low speed during vector control. The value of the parameter is a GAIN. The higher the value, the more vibration dampening that will occur.

**Group 9: Communication Parameters****09 - 00**  Communication Address

Factory Setting: 01

Settings      01-254  
                   00: Disabled

 If the AC drive is controlled by RS-485 serial communication, the communication address for this drive must be set via this parameter.

**09 - 01**  Transmission Speed (Baud Rate)

Factory Setting: 01

Settings      00: Baud rate 4800  
                   01: Baud rate 9600  
                   02: Baud rate 19200  
                   03: Baud rate 38400

 This parameter determines transmission speed of AC drive communication.

**09 - 02**  Transmission Fault Treatment

Factory Setting: 03

Settings      00: Warn and keep operating  
                   01: Warn and RAMP to stop  
                   02: Warn and COAST to stop  
                   03: No warning and no display

 This parameter is set to detect if an error occurs and take actions.

**09 - 03** Time-out Detection during Transmission

Factory Setting: 00

Settings      00: Disabled  
                   01: Enabled

 This parameter is used for ASCII mode. When this parameter is set to 01, indicates that the time-out detection is enable, the time slot between each character can't exceed 500 ms.

**09 - 04** Communication Format

Factory Setting: 00

Settings      00: 7-bit for ASCII  
                   01: 8-bit for ASCII  
                   02: 8-bit for RTU



**09 - 05** Even/Odd Parity and Stopping Parity Setting

Factory Setting: 00

Settings	00: None parity + 2 stop bit
	01: Even parity + 2 stop bit
	02: Odd parity + 2 stop bit
	03: None parity + 1 stop bit
	04: Even parity + 1 stop bit
	05: Odd parity + 1 stop bit

 This parameter determines the communication format of serial communication.

**09 - 06** Communication Operation Command 1

Factory Setting: 00

Settings	Bit0~1: 00: Disabled
	01: Stop
	10: Start-up
	11: JOG start-up
	Bit2~3: Reserved
	Bit4~5: 00: Disabled
	01: FWD command
	10: REV command
	11: Direction change command
	Bit6~7: 00: 1st step acce/decel speed
	01: 2nd step acce/decel speed
	10: 3rd step acce/decel speed
	11: 4th step acce/decel speed
	Bit8~11: 0000: Master speed
	0001: 1st step speed
	0010: 2nd step speed
	0011: 3rd step speed
	0100: 4th step speed
	0101: 5th step speed
	0110: 6th step speed
	0111: 7th step speed
	1000: 8th step speed
	1001: 9th step speed
	1010: 10th step speed
	1011: 11th step speed
	1100: 12th step speed
	1101: 13th step speed
	1110: 14th step speed
	1111: 15th step speed
	Bit12: Select Bit6~11 function
	Bit13~15: Reserved

 This parameter can be set by communication settings. It can't be set by keypad.

---

**09 - 07**  Communication Frequency Setting

Unit: 0.01

Settings 0~160.00Hz

Factory Setting: 60.00

 This parameter can be set by communication settings. It can't be set by keypad.

---

**09 - 08**  Communication Operation Command 2

Factory Setting: 00

Settings Bit0: 1: EF ON  
 Bit1: 1: Reset  
 Bit2: 0: BB OFF, 1: BB ON  
 Bit3~15: Reserved

 This parameter can be set by communication settings. It can't be set by keypad.

 If you set BB action by this parameter and you also need to disable BB action by this parameter.

1. There is a built-in RS-485 serial interface, marked (RJ-11 jack) on the control terminal block.

The pins are defined below:

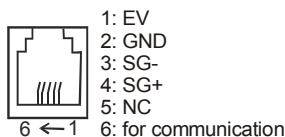

Each AC drive has a pre-assigned communication address specified by 9-00. The computer then controls each AC drive according to its communication address.

AC drive can be setup to communicate on Modbus networks using one of the following modes: ASCII (American Standard Code for Information interchange) or RTU (Remote Terminal Unit). Users can select the desired mode along with the serial port communication protocol in 09-04 and 09-05.

Code Description:

ASCII mode:

Each 8-bit data is the combination of two ASCII characters. For example, a 1-byte data: 64 Hex, shown as '64' in ASCII, consists of '6' (36Hex) and '4' (34Hex).

Character	'0'	'1'	'2'	'3'	'4'	'5'	'6'	'7'
ASCII Code	30H	31H	32H	33H	34H	35H	36H	37H

Character	'8'	'9'	'A'	'B'	'C'	'D'	'E'	'F'
ASCII Code	38H	39H	41H	42H	43H	44H	45H	46H

RTU mode:

Each 8-bit is the combination of two 4-bit hexadecimal characters. For example, 64 Hex.

2. Data format

2.1 10-bit character frame (for 7-bit):

❖ (7, N, 2: 9-04=0, 9-05=0)

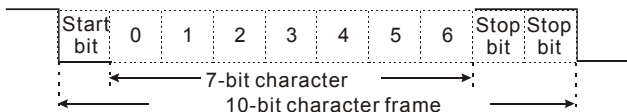

❖ (7, E, 1: 9-04=0, 9-05=04)

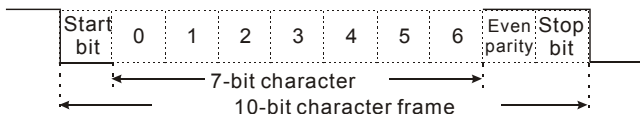

❖ (7, O, 1: 9-04=0, 9-05=05)

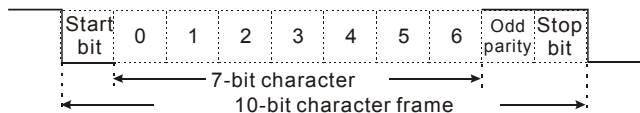

2.2 11-bit character frame (for 8-bit):

❖ (8, N, 2: 9-04=1 or 2, 9-05=00)

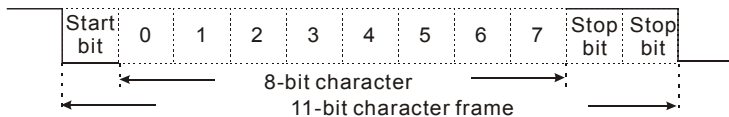

❖ (8, E, 1: 9-04=1 or 2, 9-05=04)

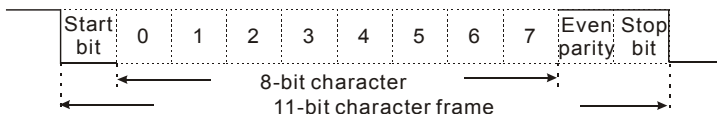

❖ (8, O, 1: 9-04=1 or 2, 9-05=05)

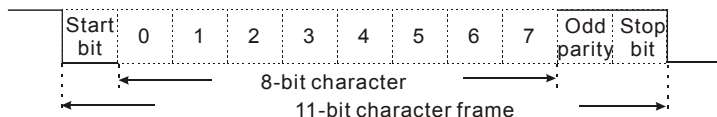

## 3. Communication Protocol

## 3.1 Communication Data Frame:

**ASCII mode:**

STX	Start character ':' (3AH)
ADR 1	Communication address: 8-bit address consists of 2 ASCII codes
ADR 0	
CMD 1	Command code: 8-bit command consists of 2 ASCII codes
CMD 0	
DATA (n-1)	Contents of data: N X 8-bit data consists of 2n ASCII codes. n<=25, maximum of 50 ASCII codes
.....	
DATA 0	
LRC CHK 1	LRC check sum: 8-bit check sum consists of 2 ASCII codes
LRC CHK 0	
END 1	End characters: END1= CR (0DH), END0= LF(0AH)
END 0	

**RTU mode:**

START	A silent interval of more than 10 ms
ADR	Communication address: 8-bit address
CMD	Command code: 8-bit command
DATA (n-1)	Contents of data: N X 8-bit data, n<=25
.....	
DATA 0	
CRC CHK Low	CRC check sum: 16-bit check sum consists of 2 8-bit characters
CRC CHK High	
END	A silent interval of more than 10 ms

## 3.2 ADR (communication address)

Valid communication addresses are in the range of 0 to 254. a communication address equal to 0, means broadcast to all AC drives (AMD). In this case, the AMD will not reply any message to the master device.

For example, communication to AMD with address 16 decimal:

ASCII mode: (ADR 1, ADR 0) = '1','0' => '1'=31H, '0'=30H

RTU mode: (ADR) = 10H

## 3.3 CMD (command code) and DATA (data character)

The format of data characters depends on the command code. The available command codes are described as followed:

- Command code: 03H, read N words. The maximum value of N is 10.

For example, reading parameters 01-01 and 01-02 from address 01H.

**ASCII mode:**

Command message:

STX	':'
ADR 1	'0'
ADR 0	'1'
CMD 1	'0'
CMD 0	'3'
Starting data address	'0'
	'1'
	'0'
	'1'
Number of data (Word)	'0'
	'0'
	'0'
	'2'
LRC CHK 1	'D'
LRC CHK 0	'7'
END 1	CR
END 0	LF

Response message:

STX	':'
ADR 1	'0'
ADR 0	'1'
CMD 1	'0'
CMD 0	'3'
Number of data(Word)	'0'
	'4'
Data of 0101H	'1'
	'7'
	'7'
Data of 0102H	'0'
	'8'
	'8'
LRC CHK 1	'D'
LRC CHK 0	'1'
END 1	CR
END 0	LF

Error response message

STX	':'
ADR 1	'0'
ADR 0	'1'
CMD 1	'8'
CMD 0	'3'
Error code	'0'
	'2'
LRC CHK 0	'6'
LRC CHK 1	'D'
END 1	CR
END 0	LF

**RTU mode:**

Command message:

ADR	01H
CMD	03H
Starting data address	01H
	01H
Number of data (Word)	00H'
	02H
CRC CHK Low	94H
CRC CHK High	37H

Response message:

ADR	01H
CMD	03H
Number of data	04H
data 0101H content	17H
	70H
0102H content	08H
	98H
CRC CHK LOW	FBH
CRC CHK HIGH	36H

Error response message

ADR	01H
CMD	90H
Error code	02H
CRC CHK LOW	CDH
CRC CHK HIGH	C1H

- Command code: 06H, write a word

For example, writing 6000(1770H) to address 0100H of AMD with address 01H.

**ASCII mode:**

Command message:

STX	':'
ADR 1	'0'
	ADR 0
CMD 1	'0'
	CMD 0
data starting address	'0'
	'1'
	'0'
	'0'
data	'1'
	'7'
	'7'
	'0'
LRC CHK 1	'7'
LRC CHK 0	'7'
END 1	CR
END 0	LF

Response message:

STX	':'
ADR 1	'0'
	ADR 0
CMD 1	'0'
	CMD 0
data starting address	'0'
	'1'
	'0'
	'0'
data	'1'
	'7'
	'7'
	'0'
LRC CHK 1	'7'
LRC CHK 0	'7'
END 1	CR
END 0	LF

Error response message

STX	':'
ADR 1	'0'
	ADR 0
CMD 1	'8'
	CMD 0
Error code	'0'
	'2'
LRC CHK 0	'6'
LRC CHK 1	'D'
END 1	CR
END 0	LF

**RTU mode:**

Command message:

ADR	01H
CMD	06H
data	01H
Starting address	00H
data	17H
	00H
CRC CHK LOW	87H
CRC CHK HIGH	C6H

Response message:

ADR	01H
CMD 1	06H
data	01H
Starting address	00H
data	17H
	70H
CRC CHK LOW	87H
CRC CHK HIGH	C6H

Error response message

ADR	01H
CMD 1	86H
Error code	02
CRC CHK LOW	C3H
CRC CHK HIGH	A1H

- Command code: 08H, loop detection

This command is used to test the communication condition between master control equipment (usually is PC or PLC) and AC drive. AC drive will deliver the data that received from AC drive to master control equipment.

For example:

**ASCII mode:**

Command message:

STX	':'
ADR 1	'0'
ADR 0	'1'
CMD 1	'0'
CMD 0	'8'
data	'0'
Starting address	'0'
	'0'
	'0'
data	'1'
	'7'
	'7'
	'0'
LRC CHK 1	'7'
LRC CHK 0	'0'
END 1	CR
END 0	LF

Response message:

STX	':'
ADR 1	'0'
ADR 0	'1'
CMD 1	'0'
CMD 0	'8'
data	'0'
Starting	'0'
	'0'
	'0'
data	'1'
	'7'
	'7'
	'0'
LRC CHK 1	'7'
LRC CHK 0	'0'
END 1	CR
END 0	LF

Error response message

STX	':'
ADR 1	'0'
ADR 0	'1'
CMD 1	'8'
CMD 0	'8'
Error code	'0'
	'2'
LRC CHK 0	'6'
LRC CHK 1	'D'
END 1	CR
END 0	LF

**RTU mode:**

Command message:

ADR	01H
CMD	08H
data	00H
Starting address	00H
data	17H
	70H
CRC CHK LOW	EEH
CRC CHK HIGH	EFH

Response message:

ADR	01H
CMD 1	08H
data	00H
Starting address	00H
data	17H
	70H
CRC CHK LOW	EEH
CRC CHK HIGH	EFH

Error response message

ADR	01H
CMD 1	88H
Error code	02
CRC CHK LOW	E0H
CRC CHK HIGH	6DH

- Command code: 10H, write continuous words

For example, modify multi-step speed setting of AC drive (address 01H)

05-00=50.00(1388H) · 05-01=40.00(0FA0H)

**ASCII mode:**

Command message:

STX	':'
ADR 1	'0'
ADR 0	'1'
CMD 1	'1'
CMD 0	'0'
Data	'0'
Starting address	'5'
	'0'
	'0'
Number Of data (Word)	'0'
	'0'
	'0'
	'2'
Number of data (Byte)	'0'
	'4'
The first data	'1'
	'3'
	'8'
	'8'
The second data	'0'
	'F'
	'A'
	'0'

Response message:

STX	':'
ADR 1	'0'
ADR 0	'1'
CMD 1	'1'
CMD 0	'0'
Data address	'0'
	'5'
	'0'
	'0'
Number Of data (Word)	'0'
	'0'
	'0'
	'2'
LRC CHK 1	'E'
LRCCHK 0	'8'
END 1	CR
END 0	LF

Error response message

STX	':'
ADR 1	'0'
ADR 0	'1'
CMD 1	'9'
CMD 0	'0'
Error code	'0'
	'2'
LRC CHK 0	'6'
LRC CHK 1	'D'
END 1	CR
END 0	LF



LRC CHK 1	'9'
LRC CHK 0	'A'
END 1	CR
END 0	LF

**RTU mode:**

Command message:

ADR	01H
CMD	10H
Data starting address	05H 00H
Number of data (Word)	00H 02H
Number of data (Byte)	04
The first data	13H 88H
The second data	0FH A0H
CRC CHK LOW	4DH
CRC CHK HIGH	D9H

Response message:

ADR	01H
CMD 1	10H
Data starting address	05H 00H
Number of data (Word)	00H 02H
CRC CHK LOW	41H
CRC CHK HIGH	04H

Error response message

ADR	01H
CMD 1	90H
Error	02H
CRC CHK LOW	CDH
CRC CHK HIGH	C1H

## 3.4 CHK (check sum)

**ASCII mode:**

LRC (Longitudinal Redundancy Check) is calculated by summing up, module 256, the values of the bytes from ADR1 to last data character then calculating the hexadecimal representation of the 2's complement negation of the sum.

For example, reading 1 word from address 0401H of the AC drive with address 01H.

STX	':'
ADR 1	'0'
ADR 0	'1'
CMD 1	'0'
CMD 0	'3'
Data starting address	'0'
	'4'
	'0'
	'1'

Number of data	'0'
	'0'
	'0'
	'1'
LRC CHK 1 LRC CHK 0	'F'
	'6'
END 1 END 0	CR
	LF

01H+03H+04H+01H+00H+01H=0AH, 2's complement of 0AH is **F6H**.

#### RTU mode:

RTU mode uses CRC (Cyclical Redundancy Check) detect value. CRC (Cyclical Redundancy Check) is calculated by the following steps:

Step 1: Load a 16-bit register (called CRC register) with FFFFH.

Step 2: Exclusive OR the first 8-bit byte of the command message with the low order byte of the 16-bit CRC register, putting the result in the CRC register.

Step 3: Examine the LSB of CRC register.

Step 4: If the LSB of CRC register is 0, shift the CRC register one bit to the right with MSB zero-filling, then repeat step 3. If the LSB of CRC register is 1, shift the CRC register one bit to the right with MSB zero-filling, Exclusive OR the CRC register with the polynomial value A001H, then repeat step 3.

Step 5: Repeat step 3 and 4 until eight shifts have been performed. When this is done, a complete 8-bit byte will have been processed.

Step 6: Repeat step 2 to 5 for the next 8-bit byte of the command message. Continue doing this until all bytes have been processed. The final contents of the CRC register are the CRC value. When transmitting the CRC value in the message, the upper and lower bytes of the CRC value must be swapped, i.e. the lower order byte will be transmitted first.

For example, read 2 words from the to address 2102H of AMD with address 01H. The CRC register content of last byte from ADR to number of data is F76FH. The command message is as following. 6FH will transmit before F7H.

Command message:

ADR	01H
CMD	03H
Data starting address	02H
	02H
Number of data (word)	00H
	02H
CRC CHK Low	6FH
CRC CHK High	F7H

The following is an example of CRC generation using C language. The function takes two arguments:

Unsigned char\* data ← a pointer to the message buffer

Unsigned char length ← the quantity of bytes in the message buffer

The function returns the CRC values as a type of unsigned integer.

```

unsigned int crc_chk(unsigned char* data, unsigned char length){
    int j;
    unsigned int reg_crc=0xFFFF;
    while(length--){
        reg_crc ^= *data++;
        for(j=0;j<8;j++){
            if(reg_crc & 0x01){ /* LSB(b0)=1 */
                reg_crc=(reg_crc>>1) ^ 0xA001;
            }else{
                reg_crc=reg_crc >>1;
            }
        }
    }
    return reg_crc;
}

```

## 3.5 Address list:

The contents of available addresses are shown as below:

Content	Address	Function			
AC drive Parameters	GGnnH	GG means parameter group, nn means parameter number, for example, the address of Pr 04-01 is 0401H. Refer to chapter 5 for the function of each parameter. When reading parameter by command code 03H, only one parameter can be read for one time.			
Command Write only	2000H	Bit 0-1	00B: Disabled 01B: Stop 10B: Run 11B: Jog + Run		
		Bit 2-3	Reserved		
		Bit 4-5	00B: Disabled 01B: FWD command 10B: REV command 11B: Direction change command		
		Bit 6-7	00B: 1st step acce/decel speed 01B: 2nd step acce/decel speed 10B: 3rd step acce/decel speed 11B: 4th step acce/decel speed		
		Bit 8-11	0000B: Master speed 0001B: 1st step speed 0010B: 2nd step speed 0011B: 3rd step speed 0100B: 4th step speed 0101B: 5th step speed 0110B: 6th step speed 0111B: 7th step speed 1000B: 8th step speed 1001B: 9th step speed 1010B: 10th step speed 1011B: 11th step speed 1100B: 12th step speed 1101B: 13th step speed 1110B: 14th step speed 1111B: 15th step speed		
		Bit 12	Select Bit6~11 function		
		Bit 13-15	Reserved		
		2001H	Freq. command		
		2002H	Bit 0	1: EF (external fault) on	
			Bit 1	1: Reset	
Bit 2	0: BB OFF 1: BB ON				

Content	Address	Function
Status monitor Read only	2100H	Fault code:
		00: No error occurred
		01: Over-current (oc)
		02: Over-voltage (ov)
		03: Overheat (oH)
		04: Overload (oL)
		05: Overload1 (oL1)
		06: External fault (EF)
		07: IGBT short circuit protection (occ)
		08: CPU failure (cF3)
		09: Hardware protection failure (HPF)
		10: Current exceeds 2 times rated current during accel (ocA)
		11: Current exceeds 2 times rated current during decel (ocd)
		12: Current exceeds 2 times rated current during steady state operation (ocn)
		13: Ground Fault (GFF)
		14: Low voltage (Lv)
		15: CPU failure 1 (cF1)
		16: CPU failure 2 (cF2)
		17: Base Block (bb)
		18: Overload (oL2)
		19: Auto accel/decel failure (cFA)
		20: Software protection enabled (codE)
		21: EF1 Emergency stop
		22: PHL (Phase-Loss)
		23: Lc (Low-current)
		24: FbL(Feedback Loss)
		25: Reserved
		26: Fan Power Fault (FANP)
		27: Fan 1 Fault (FF1)
		28: Fan 2 Fault (FF2)
		29: Fan 3 Fault (FF3)
		30: Fan 1, 2, 3 Fault (FF123)
		31: Fan 1, 2 Fault (FF12)
		32: Fan 1, 3 Fault (FF13)
33: Fan 2, 3 Fault (FF23)		
34: Gate Drive Low Voltage Protect (Fv)		

Content	Address	Function	
		35~40: Reserved	
		41: GFF hardware error (HPF1)	
		42: CC,OC hardware error (HPF2)	
		43: OC hardware error (HPF3)	
		44: OV hardware error (HPF4)	
		45: U-phase error (CF3.3)	
		46: V-phase error (CF3.4)	
		47: W-phase error (CF3.5)	
		48: OV or LV (CF3.6)	
		49: Isum error (CF3.7)	
		50: Temperature sensor error (CF3.8)	
Status monitor Read only	2101H	Status of AC drive	
		Bit 0-1	00: Run LED is off and stop led is on. (AC Drive stopping) 01: Run LED is blink and stop led is on. (AC Drive deceleration to stop) 10: Run LED is on and stop led is blink. (AC Drive standby) 11: Run LED is on and stop led is off. (AC Drive running)
		Bit 2	1: Jog on.
		Bit 3-4	00: Rev LED is off and FWD led is on. (Forward) 01: Rev LED is blink and FWD led is on. (Reverse to Forward) 10: Rev LED is on and FWD led is blink. (Forward to Reverse) 11: Rev LED is on and FWD led is off. (Reverse)
		Bit 5-7	Reserved
		Bit 8	Master frequency source via communication interface
		Bit 9	Master frequency source via analog
		Bit 10	Running command via communication interface
		Bit 11	Parameter locked
		Bit 12-15	Reserved
	2102H	Frequency command (F)	
	2103H	Output frequency (H)	
	2104H	Output current (AXXX.X)	
	2105H	DC-BUS Voltage U (XXX.X)	
2106H	Output voltage E (XXX.X)		
2107H	Power Factor (n)		

Content	Address	Function
	2108H	Output power (XX.XXKW)
	2109H	Feedback Signal
	210AH	Feedback Signal (%)
	210BH	Estimated torque ratio
	210CH	User output (Low) uL 0-99.99
	210DH	User output (High) uH 0-9999
	210EH	PLC Time
	210FH	Reserved

### 3.6 Exception response:

The AC drive is expected to return a normal response after receiving command messages from the master device. The following depicts the conditions that no normal response is replied to the master device.

The AC drive does not receive the messages due to a communication error; thus, the AC drive has no response. The master device will eventually process a timeout condition.

The AC drive receives the messages without a communication error, but cannot handle it, an exception response will return to the master device and an error message "CExx" will display on the keypad of AC drive. The xx of "CExx" is a decimal code equal to the exception code that will describe below.

In the exception response, the most significant bit of the original command code is set to 1, and an exception code explains the condition that caused the exception is returned. An example of exception response of command code 06H and exception code 02H:

#### ASCII mode:

STX	':'
ADR 1	'0'
ADR 0	'1'
CMD 1	'8'
CMD 0	'6'
Error code	'0'
	'2'
LRC CHK 1	'7'
LRC CHK 0	'7'
END 1	CR
END 0	LF

#### RTU mode:

ADR	01H
CMD	86H
Exception code	02H
CRC CHK Low	C3H
CRC CHK High	A1H

The explanation of exception codes:

Exception code	Explanation
01	Illegal command code: The command code received in the command message is not available for the AC drive.
02	Illegal data address: The data address received in the command message is not available for the AC drive.
03	Illegal data value: The data value received in the command message is not available for the AC drive.
04	Slave device failure: The AC drive is unable to perform the requested action.
10	Communication time-out:





**Group 10: PID Control Parameters****10 - 00** Input Terminal for PID Feedback

Factory Setting: 00

Settings      00: Disabled  
                  01: Input via AI1  
                  02: Input via AI2  
                  03: Input via External Reference

 This parameter is to set the source of PID control feedback signal. The source could be AI1, AI2 or external reference that defined by 04-20.

 When this parameter is set to 00, PID feedback control function is disabled.

 If this parameter isn't set to 00, AC drive will automatically start-up PID feedback control. Output frequency is calculated by master frequency and PID feedback signal.

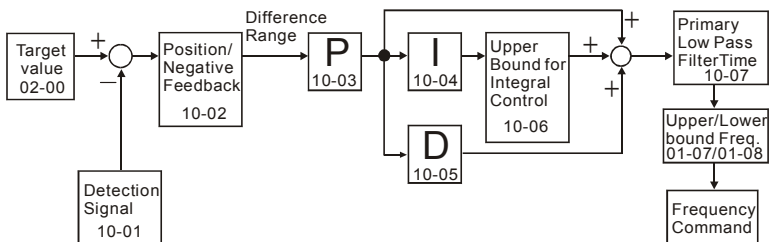
**10 - 01** PID Control Detection Signal Reference

Unit: 0.1

Settings      1.0-6550.0

Factory Setting: 1000.0

 Please refer to 04-05 to 04-12 if this parameter is set to PID feedback control.

**10 - 02** PID Feedback Control Method

Factory Setting: 00

Settings      00: Normal (Err=SP-FB)  
                  01: Inverse (Err=FB-SP)

 This parameter could set the calculation method of deviation signal during PID feedback control circuit.



 When this parameter is set to 00: when negative feedback control, the deviation equation is deviation = target value - detection signal. When increasing output frequency will increase detection value, this setting should be chose.

-  When this parameter is set to 01: when positive control, the deviation equation is deviation = detection signal - target value. When increasing output frequency will decrease detection value, this setting should be chose.



<b>10 - 03</b>	<b>Proportional Gain (P)</b>	Unit: 0.1
Settings	0.0~10.0	Factory Setting: 1.0

-  This parameter is to set proportional gain (P). This gain determines the response degree of P controller to feedback deviation. If gain value is large, the response is fast. But if the gain value is too great, oscillation will occur. If gain value is small, the response is slow.

<b>10 - 04</b>	<b>Integral Time (I)</b>	Unit: 0.01
Settings	0.00~100.00 Sec	Factory Setting: 1.00

-  This parameter is set to integral gain of I controller. When much integral time is to be set, the gain of I controller is small and the response is slow. The control ability to external is poor. When less integral time is to be set, the gain of I controller is large and the response is fast. The control ability to external is fast.
-  If the setting of integral time is too small, output frequency and system may occur oscillation.
-  If integral time is set to 0.00, I controller is closed.



<b>10 - 05</b>	<b>Differential Time (D)</b>	Unit: 0.01
Settings	0.00~1.00 Sec	Factory Setting: 0.00

-  This parameter is set to D controller gain. This gain determines D controller to the response of change of deviation. Suitable differential time could decrease overshoot of P and I controller. The oscillation will be attenuation and steady quickly. But if much differential time is to be set, it may cause system oscillation.
-  Interference immunity ability is poor due to differential controller activates to change of deviation. It's not recommended to use, especially during interferences.



<b>10 - 06</b>	<b>Upper Bound for Integral Control</b>	Unit: 1
Settings	00~200%	Factory Setting: 100

-  This parameter could set the upper bound of I controller. In other words, upper bound for integral control = (01-00) X (10-04) %

<b>10 - 07</b>	Primary Low Pass Filter Time	Unit: 0.1
Settings	0.0~2.5 Sec	Factory Setting: 0.0

-  This parameter determines primary Low Pass filter time.
-  Output frequency of PID controller will filter by primary low pass function. This function could decrease change of output frequency. A long primary low pass time means filter degree is high and vice versa.
-  Unsuitable primary low pass filter time setting may cause system oscillation.

<b>10 - 08</b>	PID Feedback Signal Range	Unit: 0.01
Settings	0.01~160.00Hz	Factory Setting: 600.00

-  This parameter setting could allow the maximum of PID deviation.
-  If PID function is normally, it should control the detective value to target value accurately in the certain time. If AC drive can't control deviation in the 10-08 setting range during 10-07 setting time, it means PID feedback control is abnormal. The treatment is set as 10-10.



<b>10 - 09</b>	PID Feedback Signal Fault Treatment Time	Unit: 0.1
Settings	0.0~3600.0 Sec	Factory Setting: 0.0

-  This parameter is to set the detection time of abnormal PID derivative. If PID deviation detection time is set to 0.0, the function is disabled.

<b>10 - 10</b>	<input checked="" type="checkbox"/> PID Feedback Signal Fault Treatment	Factory Setting: 01
Settings	00: Warn and RAMP stop 01: Warn and COAST stop 02: Warn and keep operating	

-  This parameter is to set treatment of the abnormal PID deviation.

<b>10 - 11</b>	V/F Curve Selection	Factory Setting: 00
Settings	00: Determined by group 1 01: 1.5 power curve 02: 1.7 power curve 03: 2 power curve 04: 3 power curve	

-  This parameter is to set V/F curve. If this parameter isn't set to 00, parameter 01-03 and 01-04 will disable.
-  Input current of the motor could divide into two orthogonal vectors: magnetic vector and torque vector. Gap flux, which is produced by Magnetic vector, is in direct proportion with output voltage of motor. Torque vector produces torque. Torque is in direct proportion with the result of magnetic vector multiply by torque vector. In theory, if the value of magnet vector is the same with torque vector (in unsaturated flux condition), the input current is minimum. If motor loading is unsteady torque loading (loading torque is in direct proportion with speed. For example, the loading of fan or pump), loading torque is low during low speed, suitable lower input voltage will decrease input current of magnetic field to lower flux loss and iron loss of the motor and promote whole efficiency.
-  When this parameter is set to high power V/F curve and low frequency torque is lower, it is not suitable for AC drive to accel/decel quickly. If it needs to accel/decel quickly, it is not recommended to use this parameter.

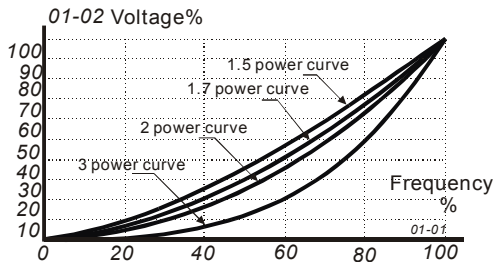

**V/F Curve Diagram**

This page intentionally left blank.

# Chapter 5 Troubleshooting

## 5.1 Over Current (OC)

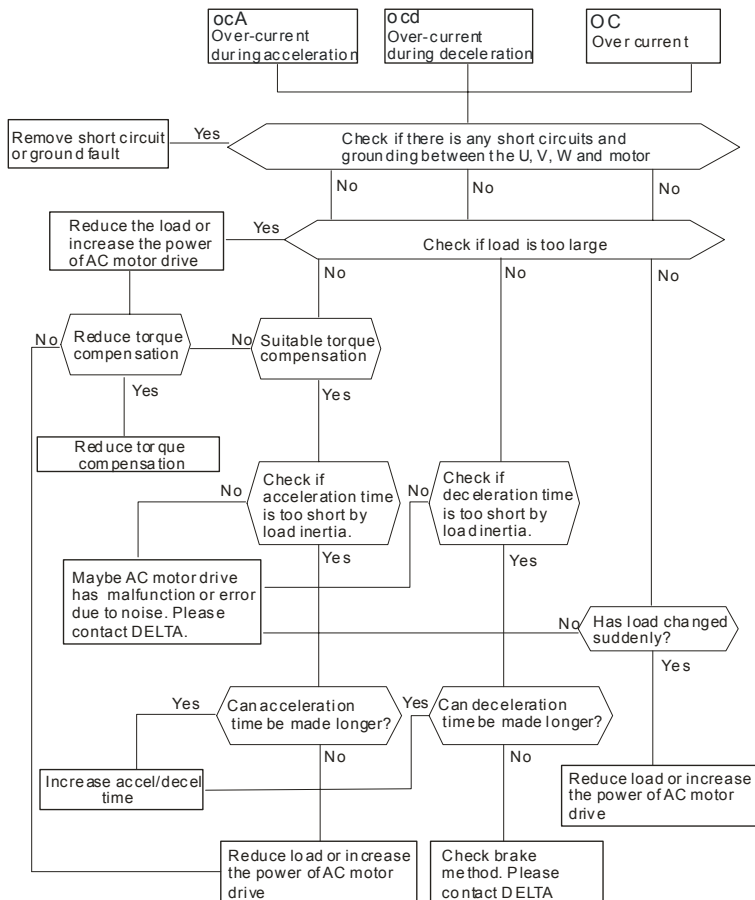

## 5.2 Ground Fault

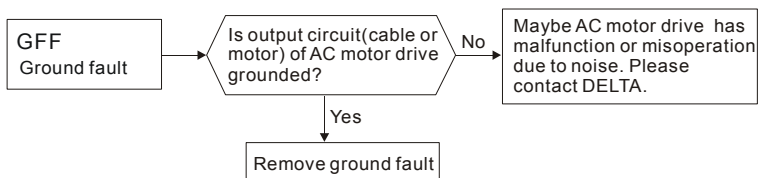

## 5.3 Over Voltage (OV)

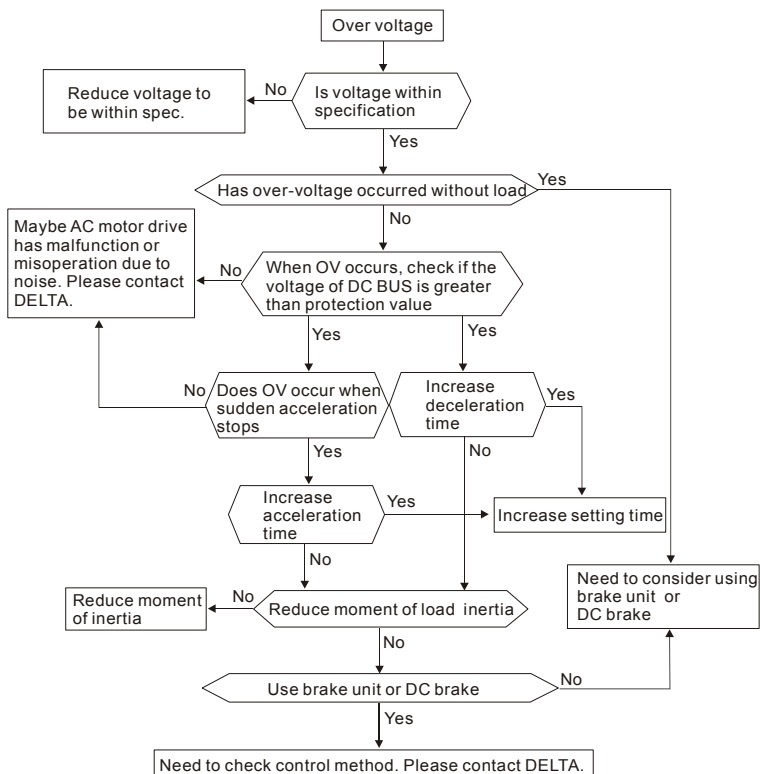

## 5.4 Low Voltage (Lv)

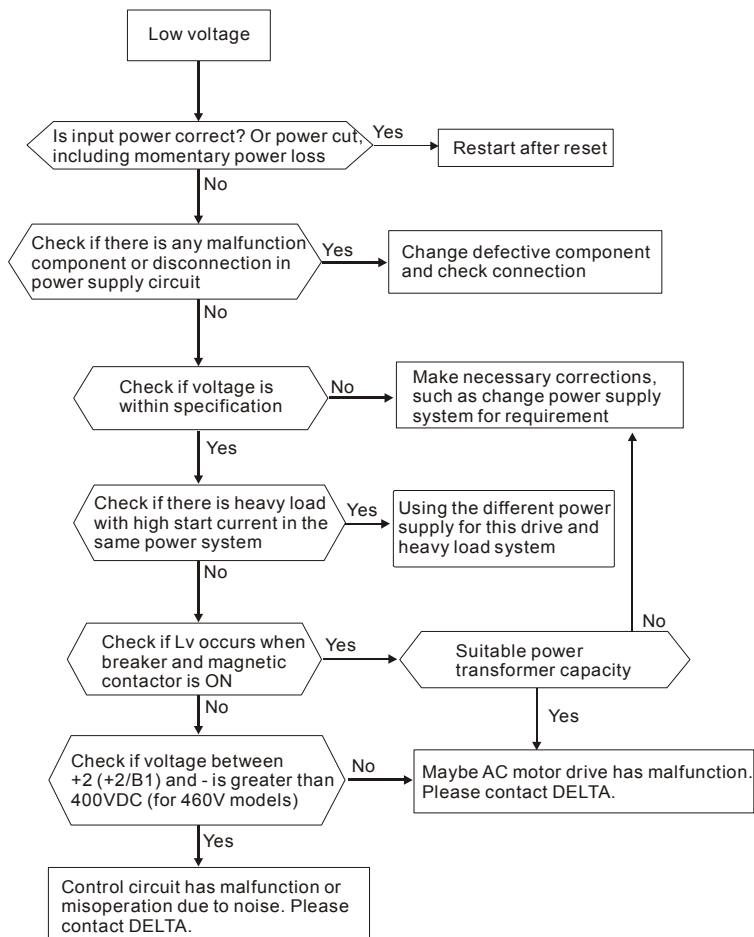



## 5.5 Over Heat (OH)

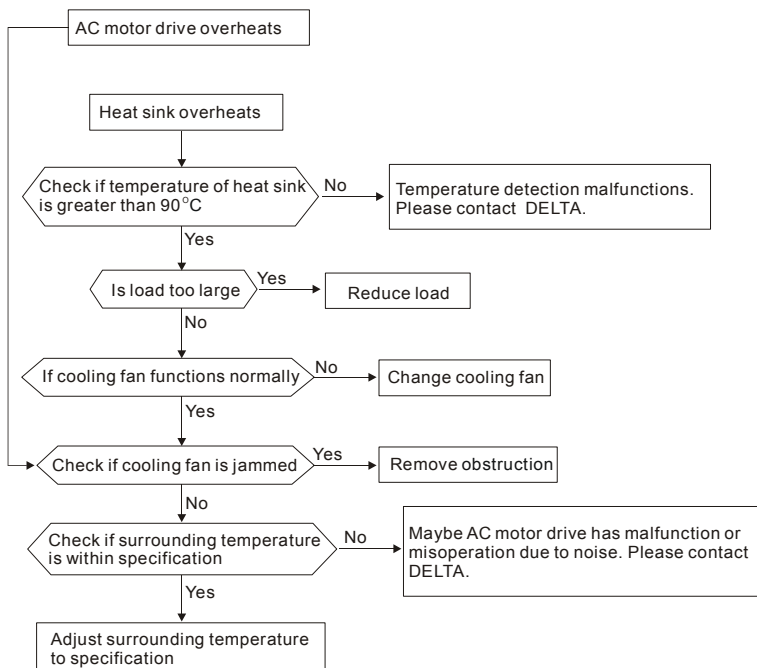

## 5.6 Overload

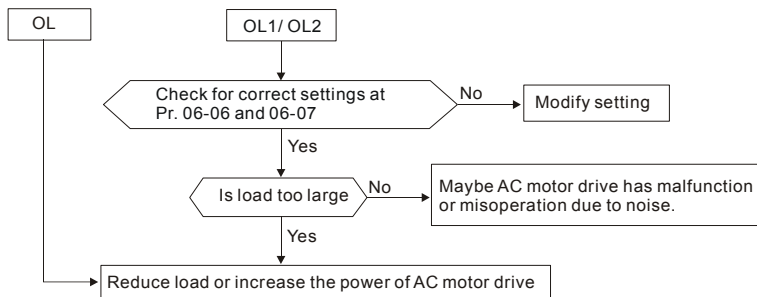

## 5.7 Keypad Display is Abnormal

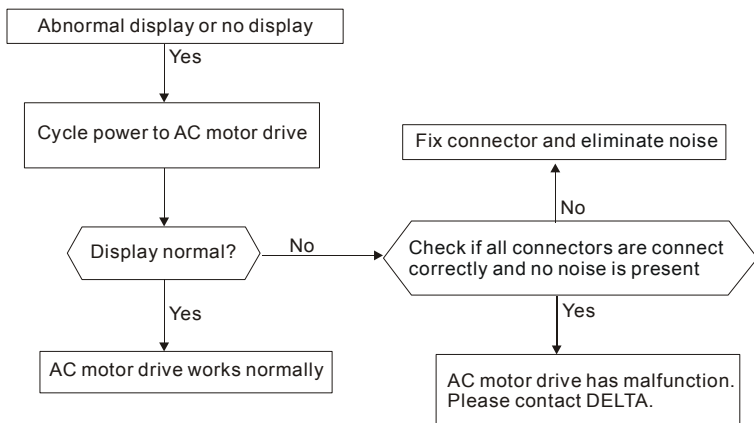

## 5.8 Phase Loss (PHL)

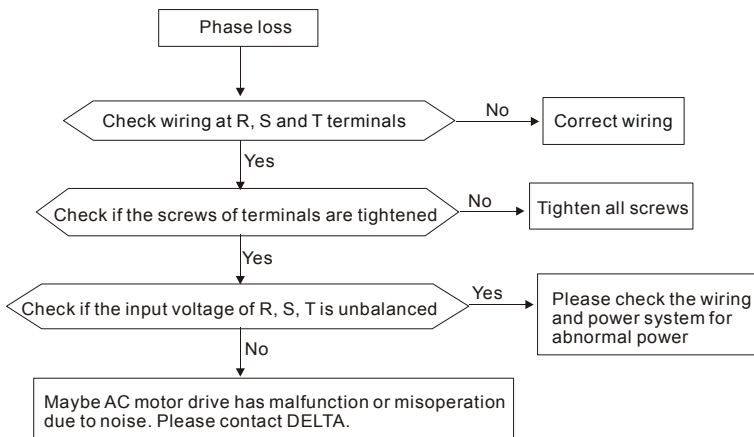





## 5.11 Motor Stalls during Acceleration

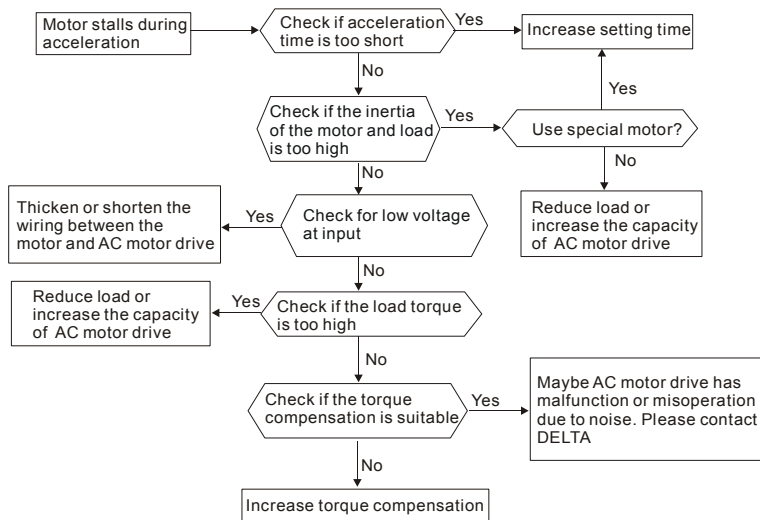

## 5.12 The Motor does not Run as Expected

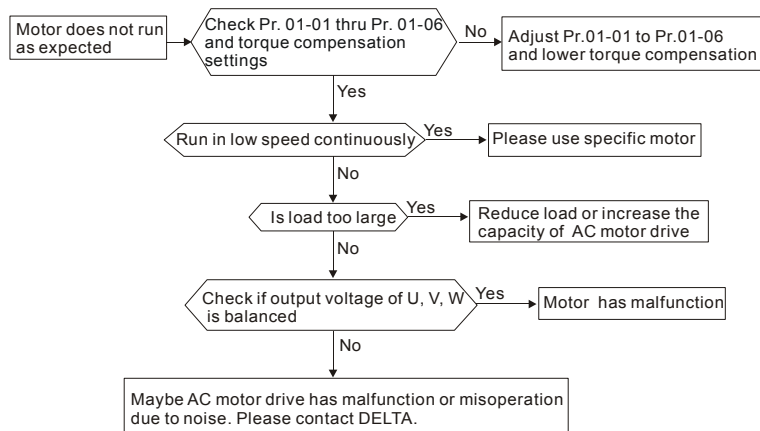

## 5.13 Electromagnetic/Induction Noise

There are many noises surround the AC motor drives and invade it by radiation or power circuit. It may cause the misoperation of control circuit and even damage the AC motor drive. Of course, that is a solution to increase the noise tolerance of AC motor drive. But it is not the best one due to the limit. Therefore, solve it from the outside as following will be the best.

1. Add surge suppressor on the relay or contact to suppress switching surge between ON/OFF.
2. Shorten the wiring length of the control circuit or serial circuit and separate from the main AC circuit wiring.
3. Comply with the wiring regulation for those shielded wire and use isolation amplifier for long wire length.
4. The grounding terminal should comply with the local regulation and ground independently, i.e. not to have common ground with electric welding machine and power equipment.
5. Connect a noise filter at the input terminal of the AC motor drive to prevent noise from power circuit.

In a word, three-level solutions for electromagnetic noise are “no product”, “no spread” and “no receive”.

## 5.14 Environmental Condition

Since the AC motor drive is an electronic device, you should comply with the environmental conditions. The following steps should also be followed.

1. To prevent vibration, anti-vibration spacer is the last choice. The vibration tolerance must be within the specification. The vibration effect is equal to the mechanical stress and it cannot occur frequently, continuously or repeatedly to prevent damaging to the AC motor drive.
2. Store in a clean and dry location free from corrosive fumes/dust to prevent corrosion and poor contacts. It also may cause short by low insulation in a humid location. The solution is to use both paint and dust-proof. For particular occasion, use the enclosure with whole-seal structure.
3. The surrounding temperature should be within the specification. Too high or low temperature will affect the lifetime and reliability. For semiconductor components, damage will occur once any specification is out of range. Therefore, it is necessary to clean and periodical check for the air cleaner and cooling fan besides having cooler and sunshade. In additional, the microcomputer may not work in extreme low temperature and needs to have heater.
4. Store within a relative humidity range of 0% to 90% and non-condensing environment. Do not turn off the air conditioner and have exsiccator for it.

## 5.15 Affecting Other Machines

AC motor drive may affect the operation of other machine due to many reasons. The solutions are as follows.

### ■ High Harmonic at Power Side

If there is high harmonic at power side during running, the improved methods are:

1. Separate power system: use transformer for AC motor drive.
2. Use reactor at the power input terminal of AC motor drive or decrease high harmonic by multiple circuit.
3. If phase lead capacitors are used (never on the AC motor drive output!!), use serial reactors to prevent capacitors damage from high harmonics.

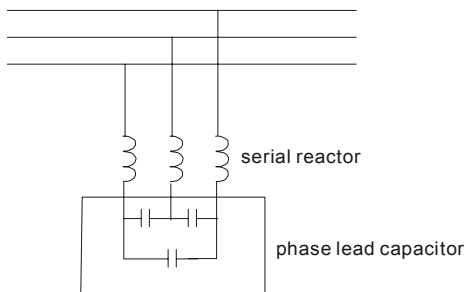

### ■ Motor Temperature Rises

When the motor is induction motor with ventilation-cooling-type used in variety speed operation, bad cooling will happen in the low speed. Therefore, it may overheat. Besides, high harmonic is in output waveform to increase copper loss and iron loss. Following measures should be used by load situation and operation range when necessary.

1. Use the motor with independent power ventilation or increase the horsepower.
2. Use inverter duty motor.
3. Do NOT run at low speeds for long time.

## Chapter 6 Fault Code Information and Maintenance

### 6.1 Fault Code Information

The AC motor drive has a comprehensive fault diagnostic system that includes several different alarms and fault messages. Once a fault is detected, the corresponding protective functions will be activated. The following faults are displayed as shown on the AC motor drive digital keypad display. The four most recent faults can be read from the digital keypad or communication.



Wait 5 seconds after a fault has been cleared before performing reset via keypad or input terminal.

#### 6.1.1 Common Problems and Solutions

Fault Name	Fault Descriptions	Corrective Actions
<b>OC</b>	The AC drive detects an abnormal increase in current.	<ol style="list-style-type: none"><li>1. Check whether the motors horsepower corresponds to the AC drive output power.</li><li>2. Check the wiring connections between the AC drive and motor for possible short circuits.</li><li>3. Increase the Acceleration time.</li></ol>
<b>OCC</b>	IGBT protection (Insulated Gate Bipolar Transistor)	<ol style="list-style-type: none"><li>4. Check for possible excessive loading conditions at the motor.</li><li>5. If there are any abnormal conditions when operating the AC drive after short-circuit being removed, it should be sent back to manufacturer.</li></ol>
<b>OU</b>	The AC drive detects that the DC bus voltage has exceeded its maximum allowable value.	<ol style="list-style-type: none"><li>1. Check whether the input voltage falls within the rated AC drive input voltage.</li><li>2. Check for possible voltage transients.</li><li>3. Bus over-voltage may also be caused by motor regeneration. Either increase the decel time or add an optional braking resistor.</li><li>4. Check whether the required braking power is within the specified limits.</li></ol>



Fault Name	Fault Descriptions	Corrective Actions
OH	The AC drive temperature sensor detects excessive heat.	<ol style="list-style-type: none"> <li>1. Ensure that the ambient temperature falls within the specified temperature range.</li> <li>2. Make sure that the ventilation holes are not obstructed.</li> <li>3. Remove any foreign objects on the heatsinks and check for possible dirty heat sink fins.</li> <li>4. Provide enough spacing for adequate ventilation.</li> </ol>
LU	The AC drive detects that the DC bus voltage has fallen below its minimum value.	Check whether the input voltage falls within the rated AC drive's input voltage.
OL	The AC drive detects excessive drive output current. Note: The AC drive can withstand up to 150% of the rated current for a maximum of 60 seconds.	<ol style="list-style-type: none"> <li>1. Check whether the motor is overloaded.</li> <li>2. Reduce torque compensation setting as set in Pr.7-02.</li> <li>3. Increase the AC drive's output capacity, i.e. bigger horsepower drive.</li> </ol>
OL1	Internal electronic overload trip	<ol style="list-style-type: none"> <li>1. Check for possible motor overload.</li> <li>2. Check electronic thermal overload setting.</li> <li>3. Increase motor capacity, i.e. larger horsepower motor.</li> <li>4. Reduce the current level so that the drive output current does not exceed the value set by the Motor Rated Current Pr.7-00.</li> </ol>
OL2	Motor overload. Check the parameter settings (Pr.6-03 to Pr.6-05)	<ol style="list-style-type: none"> <li>1. Reduce the motor load.</li> <li>2. Adjust the over-torque detection setting to an appropriate setting (Pr.06-03 to Pr.06-05).</li> </ol>
CE-	Communication Error	<ol style="list-style-type: none"> <li>1. Check the connection between the AC drive and computer for loose wires.</li> <li>2. Check if the communication protocol is properly set.</li> </ol>
OCR	Over-current during acceleration: <ol style="list-style-type: none"> <li>1. Short-circuit at motor output.</li> <li>2. Torque boost too high.</li> <li>3. Acceleration time too short.</li> <li>4. AC drive output capacity is too small.</li> </ol>	<ol style="list-style-type: none"> <li>1. Check for possible poor insulation at the output line.</li> <li>2. Decrease the torque boost setting in Pr.7-02.</li> <li>3. Increase the acceleration time.</li> <li>4. Replace with the AC drive with one that has a higher output capacity (next HP size).</li> </ol>

Fault Name	Fault Descriptions	Corrective Actions
<b>ocd</b>	Over-current during deceleration: 1. Short-circuit at motor output. 2. Deceleration time too short. 3. AC drive output capacity is too small.	1. Check for possible poor insulation at the output line. 2. Increase the deceleration time. 3. Replace with the AC drive with one that has a higher output capacity (next HP size).
<b>ocn</b>	Over-current during steady state operation: 1. Short-circuit at motor output. 2. Sudden increase in motor loading. 3. AC drive output capacity is too small.	1. Check for possible poor insulation at the output line. 2. Check for possible motor stall. 3. Replace with the AC drive with one that has a higher output capacity (next HP size).
<b>EF</b>	The external terminal EF-GND goes from OFF to ON.	1. When external terminal EF-GND is closed, the output will be turned off. (Under N.O. E.F.) 2. Press RESET after fault has been cleared.
<b>EF I</b>	Emergency stop. When the multi-function input terminals (MI1 to MI4) stop, AC drive stops any output.	Press RESET after fault has been cleared.
<b>code</b>	Software protection failure	Return to the factory.
<b>OFF</b>	Ground fault: The AC drive output is abnormal. When the output terminal is grounded (short circuit current is 50% more than the AC drive rated current), the AC drive power module may be damaged. The short circuit protection is provided for AC drive protection, not user protection.	Ground fault: 1. Check whether the IGBT power module is damaged. 2. Check for possible poor insulation at the output line.
<b>bb</b>	External Base Block. AC drive output is turned off. (Refer to Pr. 08-08)	1. When the external input terminal (B.B) is active, the AC drive output will be turned off. 2. Disable this connection and the AC drive will begin to work again.
<b>Lc</b>	Low Current	1. Check Load current 2. Check Pr.06-08 to Pr.06-10 setting
<b>PHL</b>	Phase Loss	Check Power Source Input

Fault Name	Fault Descriptions	Corrective Actions
<b>FBL</b>	Feedback Loss	Check Pr. 10-00 and wiring of feedback signal.
<b>HPF.1</b>	GFF hardware error	Return to the factory
<b>HPF.2</b>	CC (current clamp)	
<b>HPF.3</b>	OC hardware error	
<b>HPF.4</b>	OV hardware error	
<b>cF1</b>	Internal memory IC cannot be programmed.	<ol style="list-style-type: none"> <li>1. Return to the factory.</li> <li>2. Check the EEPROM on the control board.</li> </ol>
<b>cF2</b>	Internal memory IC cannot be read.	<ol style="list-style-type: none"> <li>1. Return to the factory.</li> <li>2. Reset drive to factory defaults.</li> </ol>
<b>cF33</b>	U-phase error	Return to the factory
<b>cF34</b>	V-phase error	
<b>cF35</b>	W-phase error	
<b>cF36</b>	OV or LV	
<b>cF37</b>	Isum error	
<b>cF38</b>	OH error	
<b>FAnP</b>	Fan Power Fault (150~300HP)	Return to the factory.
<b>FF1</b>	Fan 1 fault (150~300HP)	Remove any foreign objects on the heatsinks and check for possible dirty heat sink fins.
<b>FF2</b>	Fan 2 fault (150~300HP)	Remove any foreign objects on the heatsinks and check for possible dirty heat sink fins.
<b>FF3</b>	Fan 3 fault (150~300HP)	Remove any foreign objects on the heatsinks and check for possible dirty heat sink fins.
<b>FF123</b>	Fan 1, 2, 3 fault (150~300HP)	Remove any foreign objects on the heatsinks and check for possible dirty heat sink fins.
<b>FF12</b>	Fan 1, 2 fault (150~300HP)	Remove any foreign objects on the heatsinks and check for possible dirty heat sink fins.
<b>FF13</b>	Fan 1, 3 fault (150~300HP)	Remove any foreign objects on the heatsinks and check for possible dirty heat sink fins.
<b>FF23</b>	Fan 2, 3 fault (150~300HP)	Remove any foreign objects on the heatsinks and check for possible dirty heat sink fins.
<b>Fu</b>	Gate Drive Low Voltage Protect (150~300HP)	Return to the factory.

### 6.1.2 Reset

There are three methods to reset the AC motor drive after solving the fault:

1. Press  key on the digital keypad PU01.
2. Set external terminal to "RESET" (set one of Pr.04-00~Pr.04-03 to 05) and then set to be ON.
3. Send "RESET" command by communication.



#### NOTE

Make sure that RUN command or signal is OFF before executing RESET to prevent damage or personal injury due to immediate operation.

## 6.2 Maintenance and Inspections

Modern AC motor drives are based on solid-state electronics technology. Preventive maintenance is required to keep the AC motor drive in its optimal condition, and to ensure a long life. It is recommended to have a qualified technician perform a check-up of the AC motor drive regularly.

#### Daily Inspection:

Basic check-up items to detect if there were any abnormalities during operation are:

1. Whether the motors are operating as expected.
2. Whether the installation environment is abnormal.
3. Whether the cooling system is operating as expected.
4. Whether any irregular vibration or sound occurred during operation.
5. Whether the motors are overheating during operation.
6. Always check the input voltage of the AC drive with a Voltmeter.

#### Periodic Inspection:

Before the check-up, always turn off the AC input power and remove the cover. Wait at least 10 minutes after all display lamps have gone out, and then confirm that the capacitors have fully discharged by measuring the voltage between +2(+2/B1) and -. It should be less than 25VDC.

**DANGER!**

1. Disconnect AC power before processing!
2. Only qualified personnel can install, wire and maintain AC motor drives. Please take off any metal objects, such as watches and rings, before operation. And only insulated tools are allowed.
3. Never reassemble internal components or wiring.
4. Prevent static electricity.

**Periodical Maintenance****Ambient environment**

Check Items	Methods and Criterion	Maintenance Period		
		Daily	Half Year	One Year
Check the ambient temperature, humidity, vibration and see if there are any dust, gas, oil or water drops	Visual inspection and measurement with equipment with standard specification	○		
Check if there are any dangerous objects in the environment	Visual inspection	○		

**Voltage**

Check Items	Methods and Criterion	Maintenance Period		
		Daily	Half Year	One Year
Check if the voltage of main circuit and control circuit is correct	Measure with multimeter with standard specification	○		

## Keypad

Check Items	Methods and Criterion	Maintenance Period		
		Daily	Half Year	One Year
Is the display clear for reading?	Visual inspection	<input type="radio"/>		
Any missing characters?	Visual inspection	<input type="radio"/>		

## Mechanical parts

Check Items	Methods and Criterion	Maintenance Period		
		Daily	Half Year	One Year
If there is any abnormal sound or vibration	Visual and aural inspection		<input type="radio"/>	
If there are any loose screws	Tighten the screws		<input type="radio"/>	
If any part is deformed or damaged	Visual inspection		<input type="radio"/>	
If there is any color change by overheating	Visual inspection		<input type="radio"/>	
If there is any dust or dirt	Visual inspection		<input type="radio"/>	

## Main circuit

Check Items	Methods and Criterion	Maintenance Period		
		Daily	Half Year	One Year
If there are any loose or missing screws	Tighten or replace the screw	<input type="radio"/>		
If machine or insulator is deformed, cracked, damaged or with changed color change due to overheating or ageing	Visual inspection <b>NOTE: Please ignore the color change of copper plate</b>		<input type="radio"/>	
If there is any dust or dirt	Visual inspection		<input type="radio"/>	

## Terminals and wiring of main circuit

Check Items	Methods and Criterion	Maintenance Period		
		Daily	Half Year	One Year
If the wiring shows change of color change or deformation due to overheat	Visual inspection		○	
If the insulation of wiring is damaged or the color has changed	Visual inspection		○	
If there is any damage	Visual inspection		○	

## DC capacity of main circuit

Check Items	Methods and Criterion	Maintenance Period		
		Daily	Half Year	One Year
If there is any leakage of liquid, change of color, cracks or deformation	Visual inspection	○		
Measure static capacity when required	Static capacity $\geq$ initial value X 0.85		○	

## Resistor of main circuit

Check Items	Methods and Criterion	Maintenance Period		
		Daily	Half Year	One Year
If there is any peculiar smell or insulator cracks due to overheating	Visual inspection, smell		○	
If there is any disconnection	Visual inspection or measure with multimeter after removing wiring between +2(+2/B1) ~ - Resistor value should be within $\pm 10\%$		○	

**Transformer and reactor of main circuit**

Check Items	Methods and Criterion	Maintenance Period		
		Daily	Half Year	One Year
If there is any abnormal vibration or peculiar smell	Visual, aural inspection and smell	○		

**Magnetic contactor and relay of main circuit**

Check Items	Methods and Criterion	Maintenance Period		
		Daily	Half Year	One Year
If there are any loose screws	Visual and aural inspection. Tighten screw if necessary.	○		
If the contact works correctly	Visual inspection	○		

**Printed circuit board and connector of main circuit**

Check Items	Methods and Criterion	Maintenance Period		
		Daily	Half Year	One Year
If there are any loose screws and connectors	Tighten the screws and press the connectors firmly in place.		○	
If there is any peculiar smell and color change	Visual inspection and smell		○	
If there is any crack, damage, deformation or corrosion	Visual inspection		○	
If there is any leaked liquid or deformation in capacitors	Visual inspection		○	



**Cooling fan of cooling system**

Check Items	Methods and Criterion	Maintenance Period		
		Daily	Half Year	One Year
If there is any abnormal sound or vibration	Visual, aural inspection and turn the fan with hand (turn off the power before operation) to see if it rotates smoothly			○
If there is any loose screw	Tighten the screw			○
If there is any change of color due to overheating	Change fan			○

**Ventilation channel of cooling system**

Check Items	Methods and Criterion	Maintenance Period		
		Daily	Half Year	One Year
If there is any obstruction in the heat sink, air intake or air outlet	Visual inspection		○	

## Appendix A Specifications

Voltage Class		460V Class																
Model Number VFD-□□□□G43X		055	075	110	150	185	220	300	370	450	550	750	900	1100	1320	1600	1850	2200
Max. Applicable Motor Output (kW)		5.5	7.5	11	15	18.5	22	30	37	45	55	75	90	110	132	160	185	220
Max. Applicable Motor Output (HP)		7.5	10	15	20	25	30	40	50	60	75	100	125	150	175	215	250	300
Output Rating	Rated Output Capacity (KVA)	10	14	18	25	29	34	46	56	69	84	114	137	168	198	236	281	350
	Rated Output Current (A)	13	18	24	32	38	45	60	73	91	110	150	180	220	260	310	370	460
	Maximum Output Voltage (V)	Proportional to Input Voltage																
	Rated Frequency (Hz)	0.10-120.00Hz																
	Carrier Frequency (kHz)	4-6			3-6				2-6					2-4				
Input Rating	Rated Input Current (A)	14	19	25	32	39	49	60	73	91	120	160	160	200	240	300	380	400
	Rated Voltage	3-phase 342-528 V																
	Frequency Tolerance	47 – 63 Hz																

		General Specifications																
Model Number VFD-□□□□G43X		055	075	110	150	185	220	300	370	450	550	750	900	1100	1320	1600	1850	2200
Control Characteristics	Control System	SPWM (Sinusoidal Pulse Width Modulation, carrier frequency 2-6kHz)																
	Output Frequency Resolution	0.01Hz																
	Torque Characteristics	Including the auto-torque, auto-slip compensation; starting torque can be 150% at 1.0Hz																
	Overload Endurance	150% of rated current for 1 minute (F>15Hz)												120% of rated current for 1 minute				
	Accel/Decel Time	1-36000/0.1-3600.0/0.01-360.00 seconds (3 Independent settings for Accel/Decel Time)																
	V/F Pattern	Adjustable V/F pattern																
	Stall Prevention Level	20 to 150%, Setting of Rated Current																
Operating Characteristics	Frequency Setting	Keypad	Setting by ▲ ▼															
		External Signal	2 sets of analog inputs, 15 Multi-Function Inputs, RS-485 interface (MODBUS), External terminals UP/DOWN Key															
	Operation Setting Signal	Keypad	Set by RUN, STOP and JOG															
		External Signal	Operation by FWD, REV, JOG and communication operation															
	Multi-Function Input Signal	Multi-step selection 0 to 15, Jog, accel/decel inhibit, first to forth accel/decel switches, counter, external Base Block (NC, NO), JOG																
Multi-Function Output Indication	AC Drive Operating, Frequency Attained, Desired Frequency Attained, Zero speed, Base Block, Fault Indication and Local/Remote indication																	
Analog Output Signal	2 sets of Analog frequency/current signal output																	

**General Specifications**

Other Functions	AVR, 2 types of S-Curve, Over-Voltage, Over-Current Stall Prevention, Fault Records, Reverse inhibition, DC Braking, Momentary Power Loss restart, Auto torque and slip compensation, PID Control, Parameter Lock/Reset, Frequency Limits, Adjustable Carrier Frequency	
Protection	Self-testing, Over Voltage, Over Current, Under Voltage, Overload, Overheating, External Fault, Electronic thermal, Ground Fault, Phase-loss	
Cooling Methods	Forced Fan-cooled	
Environment	Installation Location	Altitude 1,000 m or lower, keep from corrosive gasses, liquid and dust
	Pollution Degree	2
	Ambient Temperature	-10°C to 40°C Non-Condensing and not frozen
	Storage/ Transportation Temperature	-20°C to 60°C
	Ambient Humidity	Below 90% RH (non-condensing)
	Vibration	9.80665m/s <sup>2</sup> (1G) less than 20Hz, 5.88m/s <sup>2</sup> (0.6G) at 20 to 50Hz

## Appendix B Accessories

### B.1 All Brake Resistors & Brake Units Used in AC Motor Drives

Note: Please only use DELTA resistors and recommended values. Other resistors and values will void Delta's warranty. Please contact your nearest Delta representative for use of special resistors. For instance, in 460 V series, 100 HP, AC drive has 2 brake units with total of 16 brake resistors, so each brake unit uses 8 brake resistors. There should be at least 10 cm away from AC drive to avoid possible noise. Refer to the "Brake Unit Module User Manual" for further detail.

Voltage	Applicable Motor		★ Full Load Torque KG-M	Equivalent Resistors Specification for Each AC Drive	Brake Unit Model VFDB No. of Unit Used		Brake Resistors Model No. of Units Used	Brake Torque 10%ED%	Minimum Equivalent Resistor Value for Each AC Drive	
	HP	kW								
460V Series	7.5	5.5	3.111	500W 100Ω			BR500W100	1	125	60Ω
	10	7.5	4.148	1000W 75Ω			BR1K0W075	1	125	45Ω
	15	11	6.186	1000W 50Ω			BR1K0W050	1	125	50Ω
	20	15	8.248	1500W 40Ω			BR1K5W040	1	125	40Ω
	25	18.5	10.281	4800W 32Ω	4030	1	BR1K2W008	4	125	32Ω
	30	22	12.338	4800W 27.2Ω	4030	1	BR1K2W6P8	4	125	27.2Ω
	40	30	16.497	6000W 20Ω	4030	1	BR1K5W005	4	125	20Ω
	50	37	20.6	9600W 16Ω	4045	1	BR1K2W008	8	125	16Ω
	60	45	24.745	9600W 13.6Ω	4045	1	BR1K2W6P8	8	125	13.6Ω
	75	55	31.11	12000W 10Ω	4030	2	BR1K5W005	8	125	10Ω
	100	75	42.7	19200W 6.8Ω	4045	2	BR1K2W6P8	16	125	6.8Ω
	120	90	52.5	13500W 5Ω	4132	1	BR1K5W005	9	120	5Ω
	150	110	61	21600W 4Ω	4132	1	BR1K2W008	18	120	4Ω
	175	132	73.5	21600W 4Ω	4132	1	BR1K2W008	18	100	4Ω
	215	160	89	21600W 3.4Ω	4132	1	BR1K2W6P8	18	97	3.4Ω
	250	185	103	27000W 2.5Ω	4132	2	BR1K5W005	18	115	2.5Ω
300	220	122.5	27000W 2.5Ω	4132	2	BR1K5W005	18	96	2.5Ω	



1. Please select the brake unit and/or brake resistor according to the table. “-“ means no Delta product. Please use the brake unit according to the Equivalent Resistor Value. “\*” means it is under development.
2. If damage to the drive or other equipment is due to the fact that the brake resistors and the brake modules in use are not provided by Delta, the warranty will be void.
3. Take into consideration the safety of the environment when installing the brake resistors.
4. If the minimum resistance value is to be utilized, consult local dealers for the calculation of the power in Watt.
5. Please select thermal relay trip contact to prevent resistor over load. Use the contact to switch power off to the AC motor drive!
6. When using more than 2 brake units, equivalent resistor value of parallel brake unit can't be less than the value in the column “Minimum Equivalent Resistor Value for Each AC Drive” (the right-most column in the table).
7. Please read the wiring information in the user manual of the brake unit thoroughly prior to installation and operation.
8. In applications with brake resistor or brake unit, Pr.06-00 (Over-voltage stall prevention) must be disabled. And Pr.08-18 (AVR function) shall not be used.
9. Definition for Brake Usage ED%

Explanation: The definition of the brake usage ED(%) is for assurance of enough time for the brake unit and brake resistor to dissipate away heat generated by braking. When the brake resistor heats up, the resistance would increase with temperature, and brake torque would decrease accordingly. Suggest cycle time is one minute.

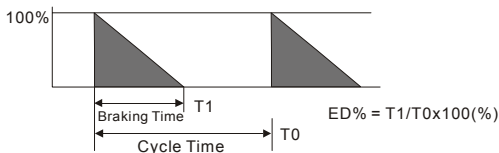

10. For safety reasons, install a thermal overload relay between brake unit and brake resistor. Together with the magnetic contactor (MC) in the mains supply circuit to the drive it offers protection in case of any malfunctioning. The purpose of installing the thermal overload relay is to protect the brake resistor against damage due to frequent braking or in case the brake unit is continuously on due to unusual high input voltage. Under these circumstances the thermal overload relay switches off the power to the drive. Never let the thermal overload relay switch off only the brake resistor as this will cause serious damage to the AC Motor Drive.

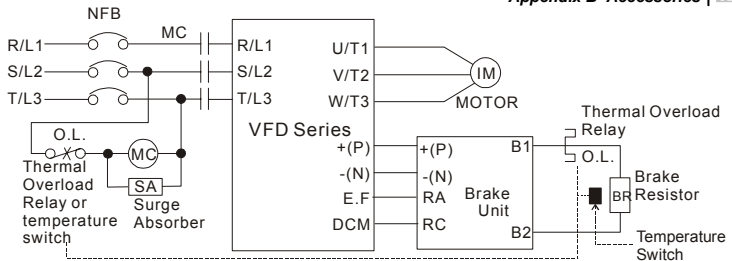

Note1: When using the AC drive with DC reactor, please refer to wiring diagram in the AC drive user manual for the wiring of terminal + (P) of Brake unit.

Note2: **Do NOT** wire terminal - (N) to the neutral point of power system.

## B.2 Non-fuse Circuit Breaker Chart

The fuse should comply with UL248 and the breaker should comply with UL489.

The current rating of the breaker shall be 2~4 times maximum output current rating.

(Refer to Appendix A for rated input/output current)

3-phase	
Model	Recommended non-fuse breaker (A)
VFD055F43B-G	30
VFD075F43B-G	40
VFD110F43A-G	50
VFD150F43A-G	60
VFD185F43A-G	75
VFD220F43A-G	100
VFD300F43A-G	125
VFD370F43A-G	150
VFD450F43A-G	175
VFD550F43A-G	250
VFD750F43A-G	300
VFD900F43C-G	300
VFD1100F43C-G	400
VFD1320F43A-G	500
VFD1600F43A-G	600
VFD1850F43A-G	600
VFD2200F43A-G	800

## B.3 Fuse Specification Chart

Smaller fuses than those shown in the table are permitted.

Model	I (A) Input	I (A) Output	Line Fuse	
			I (A)	Bussmann P/N
VFD055F43B-G	14	13	30	JJS-30
VFD075F43B-G	19	18	40	JJS-40
VFD110F43A-G	25	24	50	JJS-50
VFD150F43A-G	32	32	60	JJS-60
VFD185F43A-G	39	38	75	JJS-70
VFD220F43A-G	49	45	100	JJS-100
VFD300F43A-G	60	60	125	JJS-125
VFD370F43A-G	63	73	150	JJS-150
VFD450F43A-G	90	91	175	JJS-175
VFD550F43A-G	130	110	250	JJS-250
VFD750F43A-G	160	150	300	JJS-300
VFD900F43C-G	160	180	300	JJS-300
VFD1100F43C-G	200	220	400	JJS-400
VFD1320F43A-G	240	260	500	JJS-500
VFD1600F43A-G	300	310	600	JJS-600
VFD1850F43A-G	380	370	600	JJS-600
VFD2200F43A-G	400	460	800	JJS-800



## B.4 AC Reactor

### B.4.1 AC Input Reactor Recommended Value

460V, 50/60Hz, 3-Phase

kW	HP	Fundamental Amps	Max. continuous Amps	Inductance (mh)	
				3% impedance	5% impedance
5.5	7.5	12	18	2.5	4.2
7.5	10	18	27	1.5	2.5
11	15	25	37.5	1.2	2
15	20	35	52.5	0.8	1.2
18.5	25	35	52.5	0.8	1.2
22	30	45	67.5	0.7	1.2
30	40	55	82.5	0.5	0.85
37	50	80	120	0.4	0.7
45	60	80	120	0.4	0.7
55	75	100	150	0.3	0.45
75	100	130	195	0.2	0.3
90	125	160	240	0.15	0.23
110	150	200	300	0.11	0.185
132	175	250	375	0.09	0.15
160	215	320	480	0.075	0.125
185	250	400	560	0.06	0.105
220	300	500	700	0.05	0.085

460V DC Choke

Input Voltage	kW	HP	DC Amps	Inductance (mh)
	5.5	7.5	18	3.75
	7.5	10	25	4.00
	11	15	32	2.68
	15	20	50	2.00

18.5kW~132kW(25HP~175HP): Built-in DC Reactor

160kW~220kW(215HP~300HP): Built-in AC Reactor

**B.4.2 AC Output Reactor Recommended Value****460V, 50/60Hz, 3-Phase**

kW	HP	Fundamental Amps	Max. continuous Amps	Inductance (mh)	
				3% Impedance	5% Impedance
0.75	1	4	6	9	12
1.5	2	4	6	6.5	9
2.2	3	8	12	5	7.5
3.7	5	12	18	2.5	4.2
5.5	7.5	18	27	1.5	2.5
7.5	10	18	27	1.5	2.5
11	15	25	37.5	1.2	2
15	20	35	52.5	0.8	1.2
18.5	25	45	67.5	0.7	1.2
22	30	45	67.5	0.7	1.2
30	40	80	120	0.4	0.7
37	50	80	120	0.4	0.7
45	60	100	150	0.3	0.45
55	75	130	195	0.2	0.3
75	100	160	240	0.15	0.23

### B.4.3 Applications

Connected in input circuit

Application 1	Question
When more than one AC motor drive is connected to the same mains power, and one of them is ON during operation.	When applying power to one of the AC motor drive, the charge current of the capacitors may cause voltage dip. The AC motor drive may be damaged when over current occurs during operation.

Correct wiring

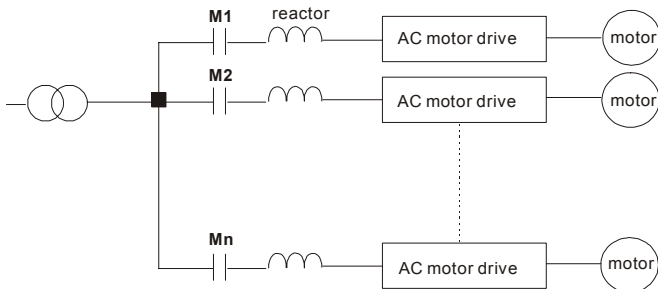

Application 2	Question
Silicon rectifier and AC motor drive are connected to the same power.	Switching spikes will be generated when the silicon rectifier switches on/off. These spikes may damage the mains circuit.

Correct wiring

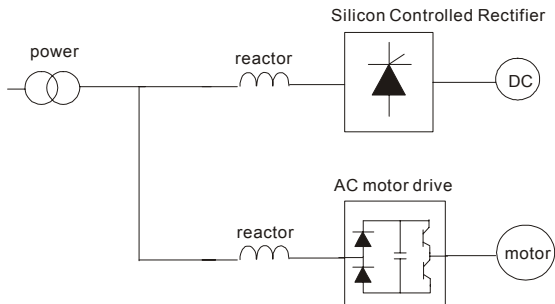

Application 3	Question
Used to improve the input power factor, to reduce harmonics and provide protection from AC line disturbances (surges, switching spikes, short interruptions, etc.). The AC line reactor should be installed when the power supply capacity is 500kVA or more and exceeds 6 times the inverter capacity, or the mains wiring distance $\leq 10\text{m}$ .	When the mains power capacity is too large, line impedance will be small and the charge current will be too high. This may damage AC motor drive due to higher rectifier temperature.

Correct wiring

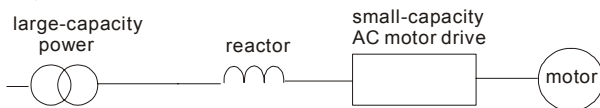

## B.5 Zero Phase Reactor (RF220X00A)

Dimensions are in millimeter and (inch)

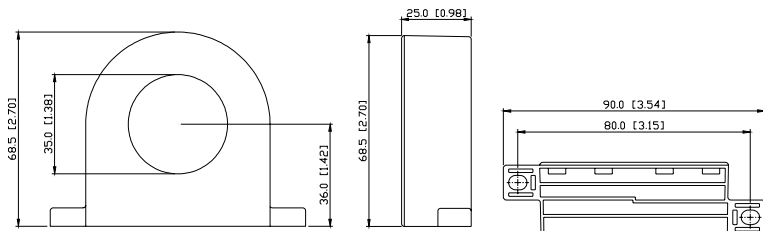

Cable type (Note)	Recommended Wire Size			Qty.	Wiring Method
	AWG	mm <sup>2</sup>	Nominal (mm <sup>2</sup> )		
Single-core	≤ 10	≤ 5.3	≤ 5.5	1	Diagram A
	≤ 2	≤ 33.6	≤ 38	4	Diagram B
Three-core	≤ 12	≤ 3.3	≤ 3.5	1	Diagram A
	≤ 1	≤ 42.4	≤ 50	4	Diagram B

**Note:** 600V Insulated unshielded Cable.

### Diagram A

Please wind each wire 4 times around the core. The reactor must be put at inverter output as close as possible.

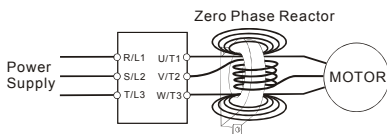

### Diagram B

Please put all wires through 4 cores in series without winding.

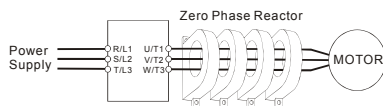

**Note 1:** The table above gives approximate wire size for the zero phase reactors but the selection is ultimately governed by the type and diameter of cable fitted i.e. the cable must fit through the center hole of zero phase reactors.

**Note 2:** Only the phase conductors should pass through, not the earth core or screen.

**Note 3:** When long motor output cables are used, an output zero phase reactor may be required to reduce radiated emissions from the cable.

## B.6 PU06

### B.6.1 Description of the Digital Keypad VFD-PU06

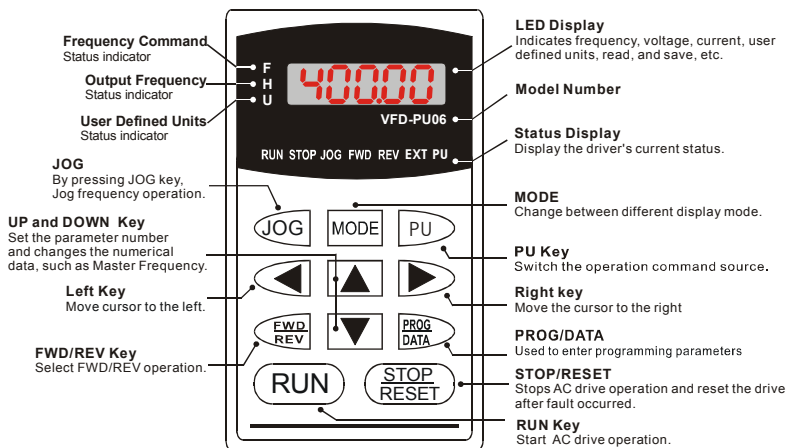

### B.6.2 Explanation of Display Message

Display Message	Descriptions
	The AC motor drive Master Frequency Command.
	The Actual Operation Frequency present at terminals U, V, and W.
	The custom unit (u)
	The output current present at terminals U, V, and W.
	Press  to change the mode to READ. Press PROG/DATA for about 2 sec or until it's flashing, read the parameters of AC drive to the digital keypad PU06. It can read 4 groups of parameters to PU06. (read 0 – read 3)
	Press  to change the mode to SAVE. Press PROG/DATA for about 2 sec or until it's flashing, then write the parameters from the digital keypad PU06 to AC drive. If it has saved, it will show the type of AC motor drive.
	The specified parameter setting.

Display Message	Descriptions
	The actual value stored in the specified parameter.
	External Fault
	"End" displays for approximately 1 second if the entered input data have been accepted. After a parameter value has been set, the new value is automatically stored in memory. To modify an entry, use the  or  keys.
	"Err" displays if the input is invalid.
	Communication Error. Please check the AC motor drive user manual (Chapter 4, Group 9 Communication Parameter) for more details.

### B.6.3 PU06 Operation Flow Chart

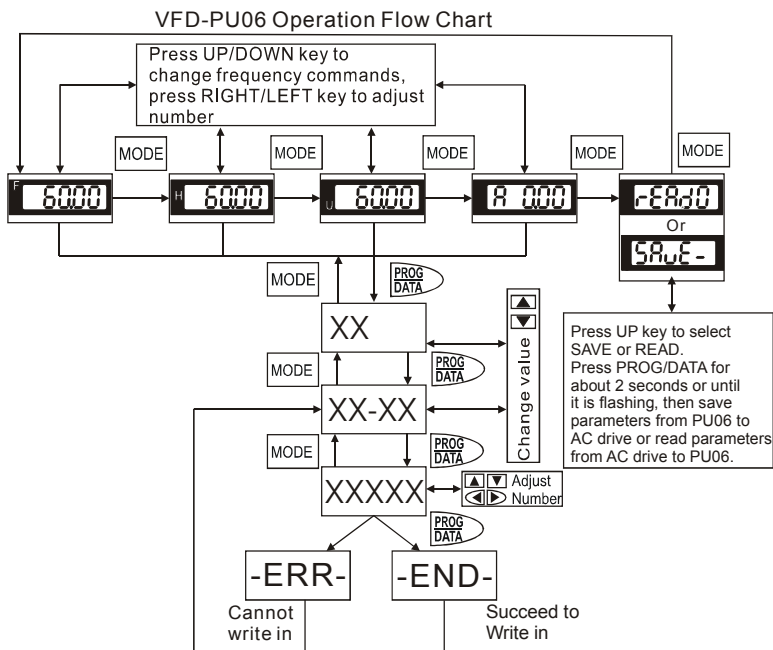

## Appendix C How to Select the Right AC Motor Drive

The choice of the right AC motor drive for the application is very important and has great influence on its lifetime. If the capacity of AC motor drive is too large, it cannot offer complete protection to the motor and motor maybe damaged. If the capacity of AC motor drive is too small, it cannot offer the required performance and the AC motor drive maybe damaged due to overloading.

But by simply selecting the AC motor drive of the same capacity as the motor, user application requirements cannot be met completely. Therefore, a designer should consider all the conditions, including load type, load speed, load characteristic, operation method, rated output, rated speed, power and the change of load capacity. The following table lists the factors you need to consider, depending on your requirements.

Item		Related Specification			
		Speed and torque characteristics	Time ratings	Overload capacity	Starting torque
Load type	Friction load and weight load Liquid (viscous) load Inertia load Load with power transmission	●			●
Load speed and torque characteristics	Constant torque Constant output Decreasing torque Decreasing output	●	●		
Load characteristics	Constant load Shock load Repetitive load High starting torque Low starting torque	●	●	●	●
Continuous operation, Short-time operation Long-time operation at medium/low speeds			●	●	
Maximum output current (instantaneous) Constant output current (continuous)		●		●	
Maximum frequency, Base frequency		●			
Power supply transformer capacity or percentage impedance Voltage fluctuations and unbalance Number of phases, single phase protection Frequency				●	●
Mechanical friction, losses in wiring				●	●
Duty cycle modification			●		



## C.1 Capacity Formulas

### 1. When one AC motor drive operates one motor

The starting capacity should be less than 1.5x rated capacity of AC motor drive

The starting capacity=

$$\frac{k \times N}{973 \times \eta \times \cos \varphi} \left( T_L + \frac{GD^2}{375} \times \frac{N}{t_A} \right) \leq 1.5 \times \text{the\_rated\_capacity\_of\_AC\_motor\_drive}(kVA)$$

### 2. When one AC motor drive operates more than one motor

2.1 The starting capacity should be less than the rated capacity of AC motor drive

- Acceleration time  $\leq 60$  seconds

The starting capacity=

$$\frac{k \times N}{\eta \times \cos \varphi} [n_r + n_s(k_s - 1)] = P_{Cl} \left[ 1 + \frac{n_s}{n_r} (k_s - 1) \right] \leq 1.5 \times \text{the\_rated\_capacity\_of\_AC\_motor\_drive}(kVA)$$

- Acceleration time  $\geq 60$  seconds

The starting capacity=

$$\frac{k \times N}{\eta \times \cos \varphi} [n_r + n_s(k_s - 1)] = P_{Cl} \left[ 1 + \frac{n_s}{n_r} (k_s - 1) \right] \leq \text{the\_rated\_capacity\_of\_AC\_motor\_drive}(kVA)$$

2.2 The current should be less than the rated current of AC motor drive(A)

- Acceleration time  $\leq 60$  seconds

$$n_r + I_M \left[ 1 + \frac{n_s}{n_r} (k_s - 1) \right] \leq 1.5 \times \text{the\_rated\_current\_of\_AC\_motor\_drive}(A)$$

- Acceleration time  $\geq 60$  seconds

$$n_r + I_M \left[ 1 + \frac{n_s}{n_r} (k_s - 1) \right] \leq \text{the\_rated\_current\_of\_AC\_motor\_drive}(A)$$

2.3 When it is running continuously

- The requirement of load capacity should be less than the capacity of AC motor drive(kVA)

The requirement of load capacity=

$$\frac{k \times P_M}{\eta \times \cos \varphi} \leq \text{the\_rated\_capacity\_of\_AC\_motor\_drive}(kVA)$$

- The motor capacity should be less than the capacity of AC motor drive

$$k \times \sqrt{3} \times V_M \times I_M \times 10^{-3} \leq \text{the\_rated\_capacity\_of\_AC\_motor\_drive}(kVA)$$

- The current should be less than the rated current of AC motor drive(A)

$$k \times I_M \leq \text{the\_rated\_current\_of\_AC\_motor\_drive}(A)$$

**Symbol explanation**

$P_M$  : Motor shaft output for load (kW)

$\eta$  : Motor efficiency (normally, approx. 0.85)

$\cos \varphi$  : Motor power factor (normally, approx. 0.75)

$V_M$  : Motor rated voltage(V)

$I_M$  : Motor rated current(A), for commercial power

$k$  : Correction factor calculated from current distortion factor (1.05 - 1.1, depending on PWM method)

$P_{C1}$  : Continuous motor capacity (kVA)  $P_{C1} = KP_{MT} / \eta \cos$

$k_S$  : Starting current/rated current of motor

$n_T$  : Number of motors in parallel

$n_S$  : Number of simultaneously started motors

$GD^2$  : Total inertia ( $GD^2$ ) calculated back to motor shaft ( $\text{kg m}^2$ )

$T_L$  : Load torque

$t_A$  : Motor acceleration time

N : Motor speed

## C.2 General Precaution

### Selection Note

1. When the AC Motor Drive is connected directly to a large-capacity power transformer (600kVA or above) or when a phase lead capacitor is switched, excess peak currents may occur in the power input circuit and the converter section may be damaged. To avoid this, use an AC input reactor (optional) before AC Motor Drive mains input to reduce the current and improve the input power efficiency.
2. When a special motor is used or more than one motor is driven in parallel with a single AC Motor Drive, select the AC Motor Drive current  $\geq 1.25 \times (\text{Sum of the motor rated currents})$ .
3. The starting and accel./decel. characteristics of a motor are limited by the rated current and the overload protection of the AC Motor Drive. Compared to running the motor D.O.L. (Direct On-Line), a lower starting torque output with AC Motor Drive can be expected. If higher starting torque is required (such as for elevators, mixers, tooling machines, etc.) use an AC Motor Drive of higher capacity or increase the capacities for both the motor and the AC Motor Drive.
4. When an error occurs on the drive, a protective circuit will be activated and the AC Motor Drive output is turned off. Then the motor will coast to stop. For an emergency stop, an external mechanical brake is needed to quickly stop the motor.

### Parameter Settings Note

1. The AC Motor Drive can be driven at an output frequency up to 400Hz (less for some models) with the digital keypad. Setting errors may create a dangerous situation. For safety, the use of the upper limit frequency function is strongly recommended.
2. High DC brake operating voltages and long operation time (at low frequencies) may cause overheating of the motor. In that case, forced external motor cooling is recommended.
3. Motor accel./decel. time is determined by motor rated torque, load torque, and load inertia.

- If the stall prevention function is activated, the accel./decel. time is automatically extended to a length that the AC Motor Drive can handle. If the motor needs to decelerate within a certain time with high load inertia that can't be handled by the AC Motor Drive in the required time, either use an external brake resistor and/or brake unit, depending on the model, (to shorten deceleration time only) or increase the capacity for both the motor and the AC Motor Drive.

### C.3 How to Choose a Suitable Motor

#### Standard motor

When using the AC Motor Drive to operate a standard 3-phase induction motor, take the following precautions:

- The energy loss is greater than for an inverter duty motor.
- Avoid running motor at low speed for a long time. Under this condition, the motor temperature may rise above the motor rating due to limited airflow produced by the motor's fan. Consider external forced motor cooling.
- When the standard motor operates at low speed for long time, the output load must be decreased.
- The load tolerance of a standard motor is as follows:

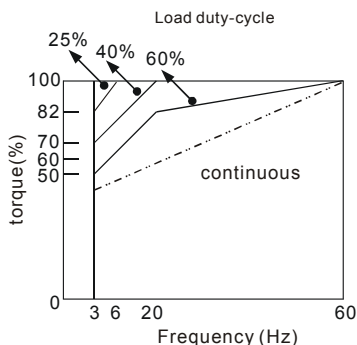

- If 100% continuous torque is required at low speed, it may be necessary to use a special inverter duty motor.
- Motor dynamic balance and rotor endurance should be considered once the operating speed exceeds the rated speed (60Hz) of a standard motor.

7. Motor torque characteristics vary when an AC Motor Drive instead of commercial power supply drives the motor. Check the load torque characteristics of the machine to be connected.
8. Because of the high carrier frequency PWM control of the VFD series, pay attention to the following motor vibration problems:
  - *Resonant mechanical vibration: anti-vibration (damping) rubbers should be used to mount equipment that runs at varying speed.*
  - *Motor imbalance: special care is required for operation at 50 or 60 Hz and higher frequency.*
  - *To avoid resonances, use the Skip frequencies.*
9. The motor fan will be very noisy when the motor speed exceeds 50 or 60Hz.

#### Special motors:

1. Pole-changing (Dahlander) motor:

The rated current is differs from that of a standard motor. Please check before operation and select the capacity of the AC motor drive carefully. When changing the pole number the motor needs to be stopped first. If over current occurs during operation or regenerative voltage is too high, please let the motor free run to stop (coast).
2. Submersible motor:

The rated current is higher than that of a standard motor. Please check before operation and choose the capacity of the AC motor drive carefully. With long motor cable between AC motor drive and motor, available motor torque is reduced.
3. Explosion-proof (Ex) motor:

Needs to be installed in a safe place and the wiring should comply with the (Ex) requirements. Delta AC Motor Drives are not suitable for (Ex) areas with special precautions.
4. Gear reduction motor:

The lubricating method of reduction gearbox and speed range for continuous operation will be different and depending on brand. The lubricating function for operating long time at low speed and for high-speed operation needs to be considered carefully.

5. Synchronous motor:

The rated current and starting current are higher than for standard motors. Please check before operation and choose the capacity of the AC motor drive carefully. When the AC motor drive operates more than one motor, please pay attention to starting and changing the motor.

**Power Transmission Mechanism**

Pay attention to reduced lubrication when operating gear reduction motors, gearboxes, belts and chains, etc. over longer periods at low speeds. At high speeds of 50/60Hz and above, lifetime reducing noises and vibrations may occur.

**Motor torque**

The torque characteristics of a motor operated by an AC motor drive and commercial mains power are different.

Below you'll find the torque-speed characteristics of a standard motor (4-pole, 15kW):

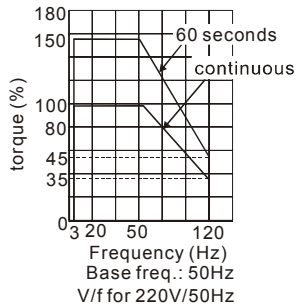
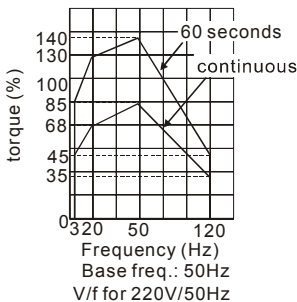
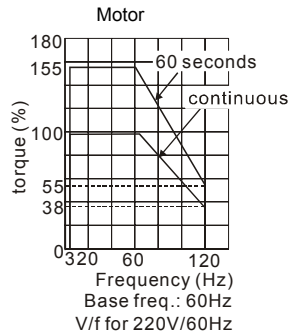
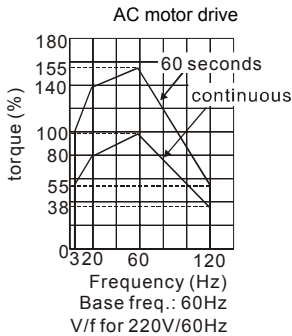

This page intentionally left blank.